

User Manual

Version 1.6 – UMIB1500INT



Evercode™ BCR Mega with INTEGRA ASSIST PLUS

(Sections 1-2)

For use with

ECIB1500 (Human)

ECIB1510 (Mouse)

ECIB1520 (Transgenic
Mouse)

INTEGRA ASSIST PLUS



Legal Notices

This document and its contents are proprietary to Parse Biosciences, Inc. ("Parse Biosciences") and are intended solely for use by its customers in connection with the use of the product(s) described herein and for no other purpose. The products may be used solely FOR RESEARCH PURPOSES, AND MAY NOT BE USED IN ANY DIAGNOSTIC OR THERAPEUTIC USE IN HUMANS OR ANIMALS. This document and its contents shall not be used or distributed for any other purpose and/ or otherwise communicated, disclosed or reproduced in any way whatsoever without the prior written consent of Parse Biosciences.

No rights are granted under this document with respect to any of Parse Biosciences' intellectual property rights. The license to use of any products described herein is subject to a separate written agreement between Parse Biosciences and the applicable user.

The instructions in this document must be strictly and explicitly followed by qualified and properly trained personnel in order to ensure the proper and safe use of the product(s) described herein. Parse Biosciences shall have no liability for any direct, indirect, consequential or incidental damages arising out of any failure to use the product(s) in strict compliance with the terms herein.

This document may contain references to third-party sources of information, hardware or software, products, or services and/ or third-party web sites (collectively "Third Party Information"). Parse Biosciences does not control, and is not responsible for, any Third Party Information. The inclusion of Third Party Information in this document does not imply endorsement by Parse Biosciences of the Third Party Information or the third party in any way.

The product(s) described in this document are provided for one-time use by the purchaser and may not be re-used, refurbished or resold. In addition, such product(s) may not be altered, changed or modified by anyone other than Parse Biosciences and its authorized agents, and Parse Biosciences will not be liable for any such alterations, changes or modifications. The product(s) described herein may be covered by one or more of the following patents:

U.S. Pat. No. 10,900,065

U.S. Pat. No. 11,168,355

U.S. Pat. No. 11,427,856

U.S. Pat. No. 11,634,751

U.S. Pat. No. 11,639,519

U.S. Pat. No. 11,680,283

Patents pending in the U.S. and other countries

PARSE and EVERCODE are trademarks of Parse Biosciences, Inc. The information made available herein is the sole property of Parse Biosciences and its licensors.

Copyright (c) 2024-2025 Parse Biosciences, Inc. All Rights Reserved.

Table of Contents

Overview	5
Workflow	5
Important Guidelines	8
Parse Reagents.....	14
Parse-Provided Equipment	19
INTEGRA Components.....	20
Consumables and Reagents	21
Equipment	23
Reading and Understanding Visuals and Diagrams	24
Section 1: Automation Setup & In Situ Barcoding	27
1.1. Sample Normalization.....	27
1.2. Load and Pool Round 1	36
1.3. Round 2 Ligation Preparation	40
1.4. Round 2 Ligation	46
1.5. Round 3 Ligation Preparation	52
1.6. Round 3 Ligation	57
1.7. Pre-Lysis.....	61
1.8. Lysis and Sublibrary Generation.....	69
Section 2: cDNA Capture and Amplification.....	72
2.1. Reagents Plating.....	72
2.2. cDNA Capture.....	78

2.3. Streptavidin Beads Wash	81
2.4. Master Mixes Preparation	82
2.5. Template Switch and cDNA Amplification	86
2.6. Post-Amplification Purification	94
2.7. cDNA Quantification	97
Appendices	98
Appendix A: Pipetting Programs	98
Appendix B: Troubleshooting.....	108
Appendix C: Revision History.....	109
Appendix D: Acknowledgements	109

Overview

Workflow

The Evercode combinatorial barcoding workflow is compatible with the INTEGRA ASSIST PLUS to enable large-scale single cell RNA-Seq experiments through a robust, semi-automated process.

Evercode split-pool combinatorial barcoding brings a simple workflow to large-scale single cell RNA-seq experiments. The Evercode BCR Mega kit can profile up to 1,000,000 cells across up to 96 different biological samples or experimental conditions. Evercode Fixation kits fix and permeabilize cells so they act as individual reaction compartments. This eliminates the need for dedicated microfluidics instrumentation. Through four rounds of barcoding, the transcriptome of each fixed cell is uniquely labeled. The four rounds of barcoding can yield a vast number of possible barcode combinations, which is more than sufficient to uniquely label up to 1,000,000 cells while avoiding doublets. After sequencing, the Parse Biosciences Analysis Pipeline assigns reads that share the same four barcode combinations to a single cell.

The Evercode BCR kit is a hybridization-based technology that captures B cells' full length V(D)J sequences.

By integrating the Evercode Mega assay kits with the ASSIST PLUS platform, the semi-automated workflow performs sample normalization and combinatorial barcoding through a series of reverse transcription, ligation, and library preparation steps.

The table below provides a high-level overview of the automated barcoding workflow.

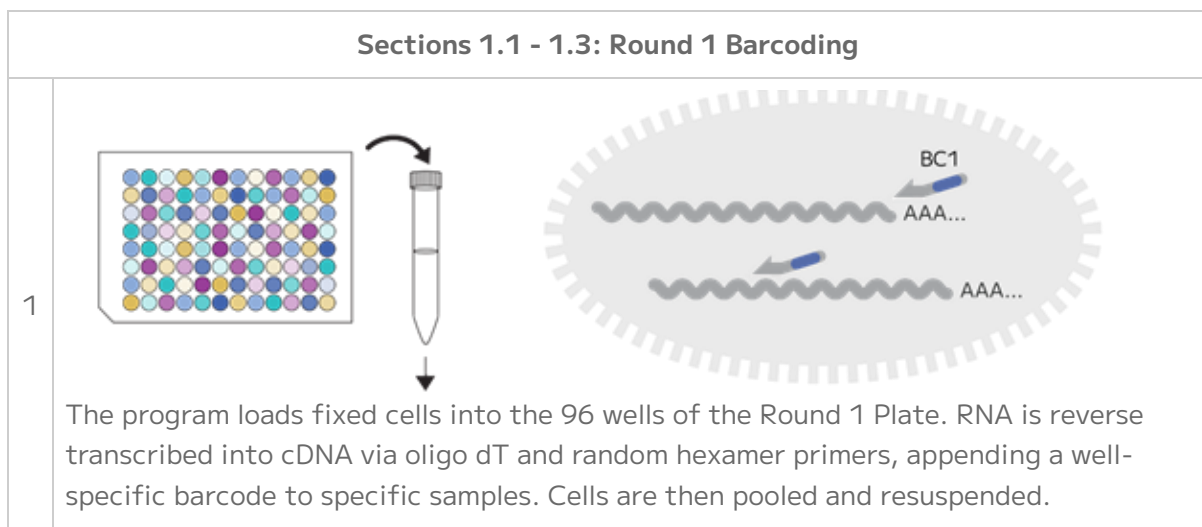

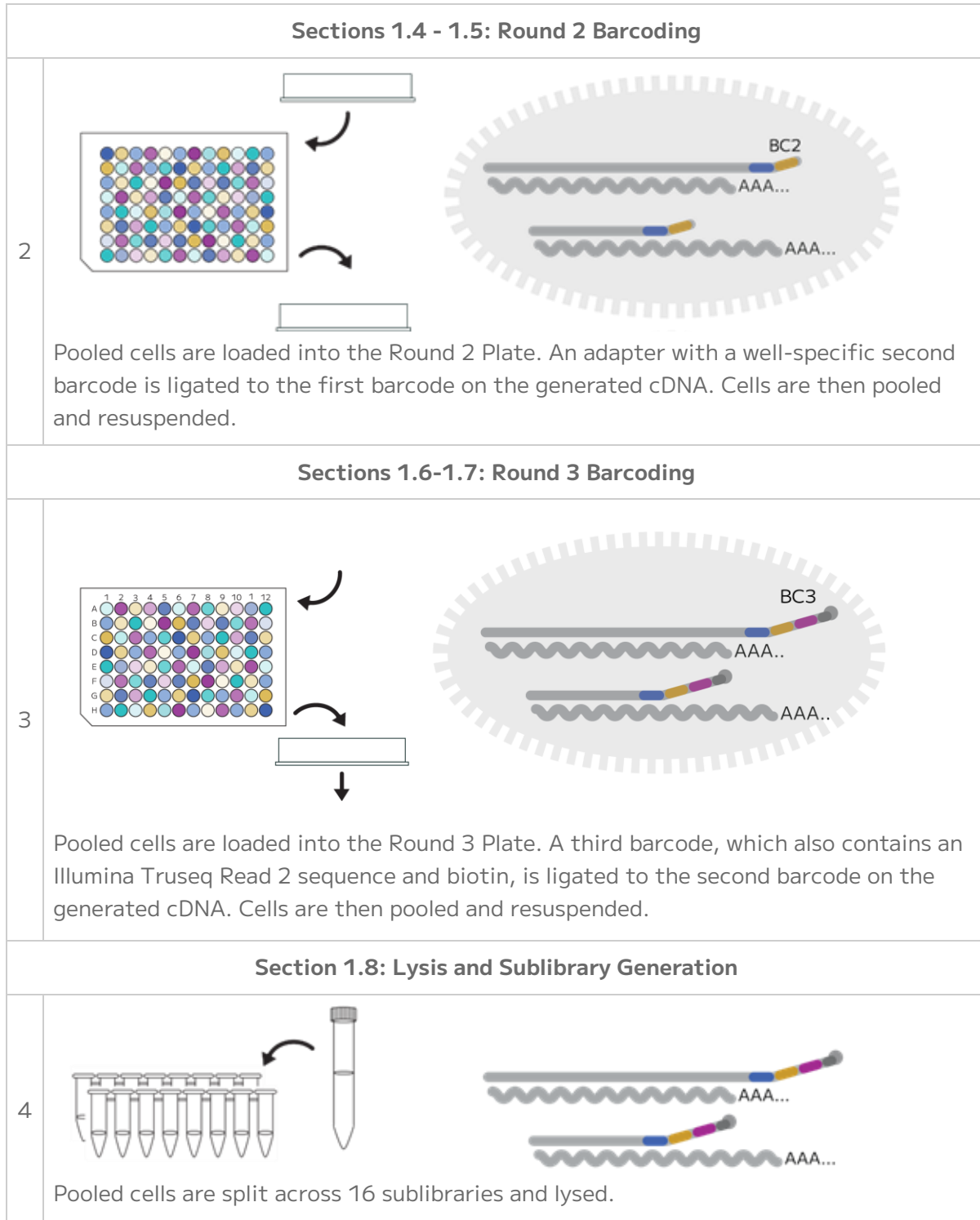

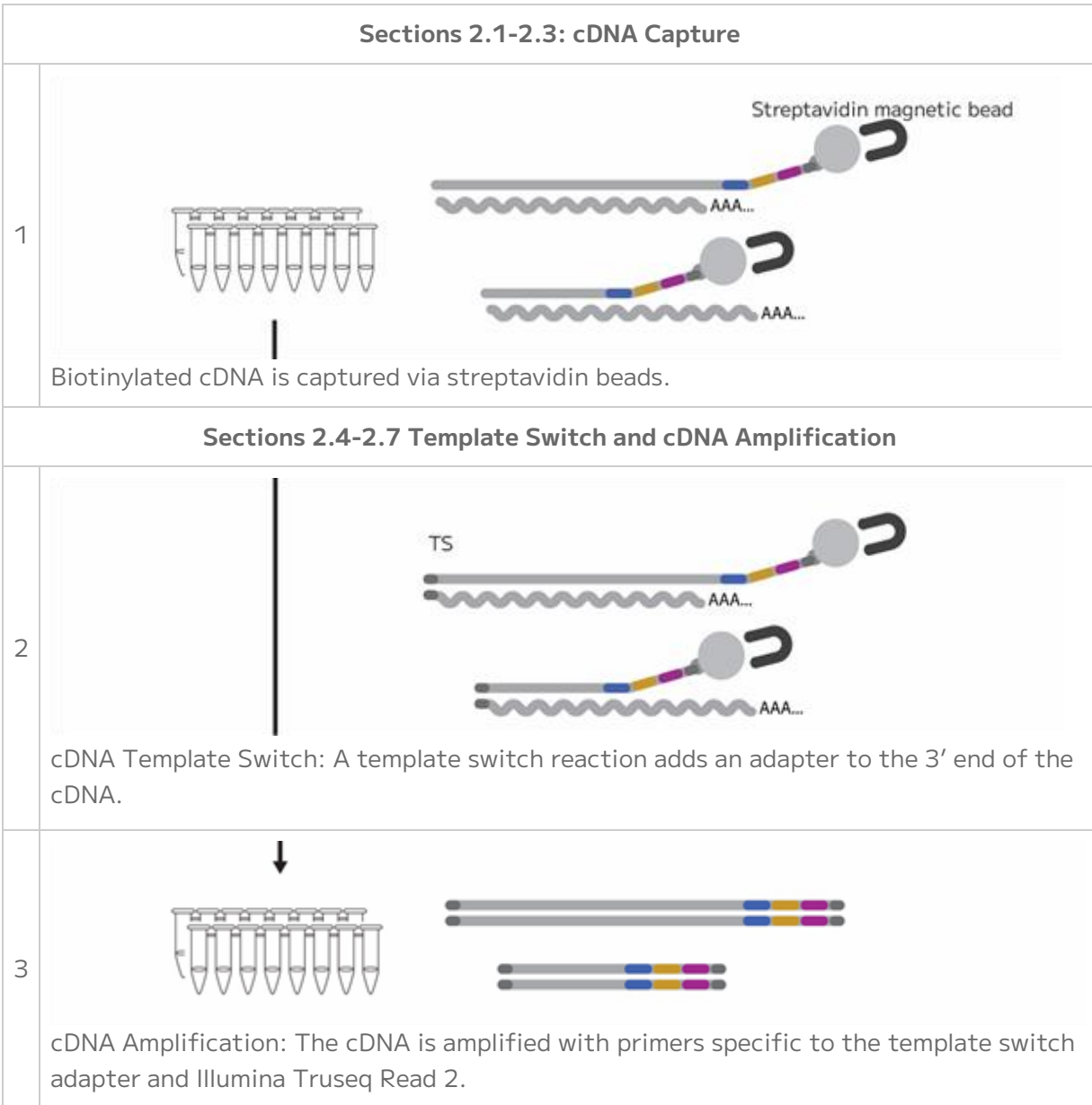

This protocol is intended to be followed when performing the Evercode Mega assays on the INTEGRA ASSIST PLUS liquid handler. The protocol replaces "Section 1. *In Situ* Cell Barcoding", "Section 2. cDNA Capture and Amplification", of the standard [Evercode BCR Mega User Guide](#). Sections 3, 4, and 5 of the user guide will need to be performed manually.

Important Guidelines

The following guidelines provide additional information to obtain optimal performance with the Evercode BCR Mega with INTEGRA ASSIST PLUS barcoding workflow.

This protocol details the automated barcoding and library preparation workflow, corresponding to Sections 1 and 2 of the standard Evercode workflow. Comprehensive guidance on optimizing the complete Evercode BCR Mega workflow is provided in the Evercode BCR Mega User Guide. For further information on the experimental or automation workflow, please contact support@parsebiosciences.com. Please contact support-us@integra-biosciences.com for any questions regarding the INTEGRA ASSIST PLUS instrument.

Sample Input

- This protocol begins with cells previously fixed with an Evercode Cell Fixation v3 kit. When working with mouse B cells, use the Evercode Mouse TCR/BCR Cell Fixation workflow, which includes a murine RNase Inhibitor.
- Samples fixed with the Standard Fixation kits are fully compatible with the INTEGRA automated barcoding workflow. To barcode samples previously fixed with the Low Input Fixation kits, we recommend beginning the automated workflow after the Barcoding 1 filter step:
 - Follow the standard User Manual instructions for the manual workflow, covering steps from Section 1.1.1 through Section 1.2.8.
 - Switch to User Manual for the automated workflow beginning with Section 1.2.1.
- Even if samples were counted before freezing, we strongly recommend counting cells again after thawing to account for any changes in cell concentration during storage and freeze/thaw. Typically, a 5-15% decrease in concentration after thawing should be expected. These counts are used to determine how cells are loaded in the Round 1 Plate, and counting accuracy at this stage is critical to recover the desired number of cells following barcoding.
- When planning on processing many fixed samples, we recommend setting aside a small "counting aliquot" of each sample at the end of fixation. These counting aliquots can be counted the day prior to starting Section 1 of any Evercode assay kit. The Evercode Fixation User Guides outline recommendations for generating aliquots. Because aliquots have undergone a similar storage time and a freeze/thaw, cell counts from these aliquots will be more representative than using counts from immediately after fixation.
- Aliquots should be thawed in a water bath set to 37°C in sets of 2-4 and counted with a hemocytometer or alternative counting device. Cell counts should be recorded in the

Sample Loading Table, and any remaining cell material in the thawed counting aliquot should be discarded.

- Once fixed samples have been thawed, they should not be refrozen.
- Samples need to be diluted into a dilution plate prior to Round 1 Barcoding. The Sample Loading Table will recommend the appropriate volume of dilution buffer needed to achieve the correct cell concentration in the required volume. If the required "Number of Sample Dilution Tubes" is greater than 1, three additional dilution buffer tubes for highly concentrated samples can be purchased as a Sample Dilution Accessory Kit (PN ECAC3901). This kit is included in the initial INTEGRA bundle, but will need to be separately purchased for subsequent orders.

Cell Counting and Quality Assessment

- We recommend a hemocytometer for counting, but alternative counting devices can also be used. If possible, validate counts from alternative devices against a hemocytometer when using Evercode kits for the first time.
- We suggest saving images of cells at each counting step. A 20x and 40x magnification provide the most useful information.
- To assess sample quality, we recommend using viability stains like trypan blue or acridine orange and propidium iodide (AO/PI).
- Examples of trypan blue stained fixed cells are shown below. High quality fixed samples have single distinct cells with <5% cell aggregation and no debris. Higher levels of aggregation will lead to elevated doublets after sequencing. When quantifying fixed samples, it is critical to avoid counting cell debris to avoid overestimating the number of cells.

High Quality Sample

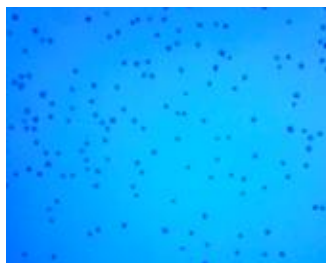

Aggregation



Debris

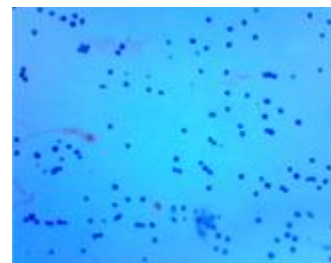

Example trypan blue stained fixed cells.

Avoiding RNase Contamination

- Take standard precautions to avoid introducing RNases into samples or reagents throughout the workflow. Always wear proper laboratory gloves and use aseptic technique.
- Although RNases are not inactivated by ethanol or isopropanol, they are inactivated by products such as RNaseZap™ RNase Decontamination Solution (Thermo Fisher Scientific®). These can be sprayed on benchtops and pipettes.
- Low retention, filtered pipette tips should be used to reduce RNase contamination from pipettes.

Centrifugation

- A range of centrifugation speeds and durations are provided in this workflow in order to optimize and balance high sample retention with resuspension efficiency. Comprehensive information to optimize centrifugation conditions for each sample type is provided in the Cells and Nuclei Fixation User Guides.
- Use a swinging bucket rotor for all high-speed centrifugation steps in this workflow. A fixed-angle rotor will lead to substantial cell loss.

Sample Loading Table

- Ensure that the Parse Evercode WT INTEGRA Mega Sample Loading Table being used is the most up-to-date version. The Sample Loading Table can be downloaded from the Parse Biosciences [Customer Support Suite](#). Customer log-in is required to access the Sample Loading Table.
- The Parse Evercode WT INTEGRA Mega Sample Loading Table (Excel spreadsheet) should be completed before starting the experiment.
- If the table isn't working as expected, ensure that Macros are enabled in the Sample Loading Table. Be sure to only edit the colored cells in the table to avoid disturbing any calculations.
- In the unlikely event that samples are not concentrated enough according to the Sample Loading Table (Excel spreadsheet), choose to either:
 - Decrease the "Max number barcoded cells" until the Sample Loading Table no longer gives an error. This will maintain the desired final library proportion between samples but barcode fewer total cells.

- Proceed as-is. The INTEGRA pipette will dispense the highest possible number of cells based on the existing concentration. This may lead to reduced library yields for samples with particularly low concentrations.

Plate Sealing

- When sealing or unsealing 96 well plates, do not splash liquid onto the PCR plate seal or between wells. Securing plates in PCR tube racks will minimize this occurrence.
- PCR plate seals may be difficult to remove. Carefully peel off the PCR plate seal while applying downward pressure on the edges of the plate to keep it in the PCR plate rack. Avoid touching the top of the open wells.

Basin Liners Usage

- Basin liners are used throughout the procedure for reagent storage. Do not use SureFlo basins, as their microwell design—intended to minimize dead volume—can unintentionally trap cells or nuclei, resulting in poor retention. Validated basins are listed in the Consumables and Reagents section.

Sample Concentrations

- For an Evercode Mega kit, samples can be pre-diluted with Sample Dilution Buffer to a more appropriate working range of 2,125-8,000 cells per μL prior to Sample Normalization on the ASSIST PLUS.
- Samples need to be diluted with Sample Dilution Buffer to the desired concentration based on the Sample Loading Table.
- For each sample we recommend preparing a 20 μL post-fixation counting aliquot and two 30-50 μL post-fixation sample aliquots. Prior to aliquoting, the samples should be thoroughly resuspended. The counting aliquot may be thawed in advance of the barcoding day to evaluate post-thaw cell recovery. The cell loss observed in this aliquot is expected to closely reflect that of the sample aliquots. Concentrations measured from the counting aliquot can then be used to update the Sample Loading Table accordingly.
- If the sample stock concentrations are too high the Sample Loading Table may indicate that more than 1 tube of Sample Dilution Buffer is needed. Additional Sample Dilution Buffer can be purchased in the Dilution Accessory Box (Parse PN ECAC3901) before starting the barcoding workflow.

Thermochromic PCR Cold Block

- The Thermochromic PCR Cold Block changes color from dark purple to bright pink (too warm) when the block temperature exceeds 7°C. If greater than 30% of the block is

bright pink, replace the Thermochromic PCR Cold Block with a fully frozen dark purple block.

- To maintain optimal performance and minimize temperature fluctuations, store the Thermochromic PCR Cold Blocks in a -20°C freezer when not in use. The blocks should be stored upside down to prevent warping.
- The Thermochromic PCR Cold Block Riser needs to be installed in the Thermochromic PCR Cold Block prior to use as illustrated below. The Riser does not need to be removed when freezing.

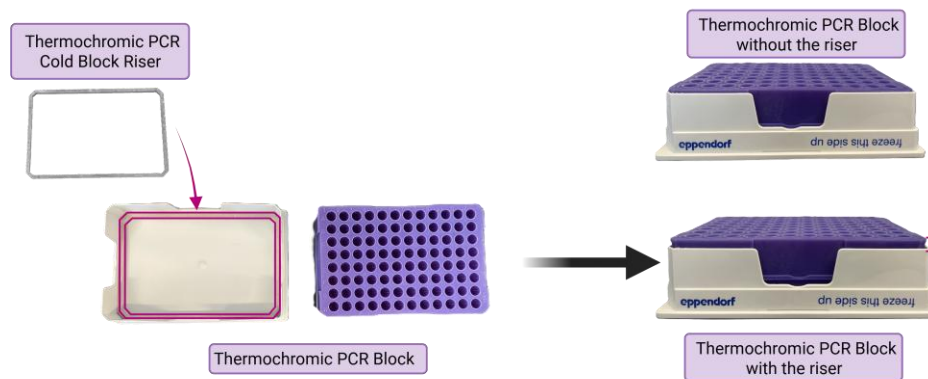

Note: Uneven freezing of the liquid inside the Thermochromic PCR Block can cause slanting of the cooling position. The Thermochromic PCR Cold Block Riser reduces the variability caused by the freezing process. If the PCR Cold Block riser is not used, there will be extra liquid left in the wells of the PCR plate during aspiration steps.

- Tip pinching may occur when using a fully frozen Thermochromic PCR Cold Block for a plate pooling step. To minimize tip pinching, a fully frozen block should be warmed slightly by a few degrees by leaving it at room temperature for 10 minutes before using it on the INTEGRA ASSIST PLUS Deck.
- To ensure a secure positioning within the Thermochromic PCR Cold Block, apply firm pressure on the PCR plates until they are securely seated. Avoid touching the top of the open wells.

Bases and Reservoirs

- Both the 300 mL Reservoir Base and the 8-Row Polystyrene Reservoir are consumables that must be purchased from INTEGRA. The 300 mL Reservoir Base is designed to securely hold the 8-Row Reservoir in place during use.



INTEGRA ASSIST PLUS Pipetting Programs

- Ensure that the VIALAB program is installed on the same Windows computer that will be used to communicate with the D-ONE Pipetting Module.
- Ensure that the Evercode workflow precheck script has been confirmed prior to running the INTEGRA + Parse workflow. This can be done by running the [Evercode WT with INTEGRA ASSIST PLUS Precheck Scripts](#) available on the Customer Support Suite.
- Ensure that the .csv worklists generated via the Parse Evercode WT INTEGRA Mega Sample Loading Table ("CombinedMegaWorksheet_YYYYMMDD_HHMMSS.csv") are accessible for upload to the VIALAB program.
- Automated pipetting programs are set up and can be selected using the pipette's user interface. In the INTEGRA + Parse workflow, prompts are built into the programs as checkpoints. When the prompt is followed by a double dash, "--", the program will continue. If the prompt does not contain a double dash, "--", it is followed by another prompt.

Deck Loading















- Always ensure the tip box placed on the deck clicks when put into place. Remove the tip box lid prior to starting the program.
- To prevent malfunctions during the procedure, ensure that all unnecessary labware is cleared from the deck before initiating a new program on the INTEGRA ASSIST PLUS.





Parse Reagents

The Evercode BCR kit includes the following boxes. Safety Data Sheets for these reagents can be provided upon request.

WT -20°C Reagents Store -20°C, PN HBG100 or MBG100

LABEL	ITEM	PN	FORMAT	QTY
	Round 1 Plate	HBG101 or MBG101	Green semi-skirted 96 well plate	1
	Round 2 Plate	MG102	Blue semi-skirted 96 well plate	1
	Round 3 Plate	MG103	Yellow semi-skirted 96 well plate	1
	Resuspension Buffer	MG104	5 mL tube	1
	Sample Dilution Buffer	MG105	2 mL tube	1
	Round 2 Ligation Buffer	MG106	5 mL tube	1
	Round 2 Ligation Enzyme	MG107	1.5 mL tube	1
	Round 2 Stop Buffer	MG108	2 mL tube	1
	Round 3 Stop Buffer	MG109	5 mL tube	1
	Pre-Lysis Wash Buffer	MG110	5 mL tube	1
	Round 3 Ligation Enzyme	MG111	1.5 mL tube	1

LABEL	ITEM	PN	FORMAT	QTY
	Pre-Lysis Dilution Buffer	MG112	2 mL tube	1
	Lysis Enzyme	MG113	1.5 mL tube	1
	Bead Wash Buffer	MG114	5 mL tube	1
	Wash Buffer 1	MG115	5 mL tube	1
	Wash Buffer 2	MG116	5 mL tube	1
	Capture Enhancer	MG117	1.5 mL tube	1
	Binding Buffer	MG118	1.5 mL tube	1
	Wash Buffer 3	MG119	5 mL tube	1
	Template Switch Buffer	MG120	2 mL tube	1
	Template Switch Enzyme	MG121	1.5 mL tube	1
	Template Switch Primer	MG122	1.5 mL tube	1
	cDNA Amp Mix	MG123	1.5 mL tube	1
	cDNA Amp Primers	MG124	1.5 mL tube	1
	Fragm/End Prep Buffer	MG125	1.5.mL tube	1

LABEL	ITEM	PN	FORMAT	QTY
	Fragm/End Prep Enzymes	MG126	1.5 mL tube	1
	Ligation Adapter	MG127	1.5 mL tube	1
	Adapter Ligation Buffer	MG128	1.5 mL tube	1
	Adapter Ligation Enzyme	MG129	1.5 mL tube	1
	Library Amp Mix	MG130	1.5 mL tube	1

WT + BCR 4°C Reagents. Store 4°C, PN HBG200 or MBG200

LABEL	ITEM	PN	FORMAT	QTY
	Spin Additive	MG201	1.5 mL tube	1
	Lysis Buffer	MG202	1.5 mL tube	1
	Streptavidin Beads	MG203	1.5 mL tube	1
	Bead Wash Buffer A	GC301	1.5 mL tube	1
	Bead Wash Buffer B	GC302	2 mL tube	1
	Streptavidin Binding Buffer	GC303	5 mL tube	1
	Streptavidin Binder Beads	GC304	1.5 mL tube	1

BCR -20°C Reagents Store at -20°C, PN HBG400, MBG400, or MBG500

LABEL	ITEM	PN	FORMAT	QTY
	Hybridization Mix	GC101	1.5 mL tube	1
	Hybridization Enhancer	GC102	1.5 mL tube	1
	Blocker Solution	GC103	1.5 mL tube	1
	Evercode Blocker Solution	GC108	0.5 mL tube	1
 or  or 	Human BCR Panel or Mouse BCR Panel or Transgenic Mouse BCR Panel	GC109 or GC110 or GC111	0.5 mL tube	1
	Enrichment Primer Mix	GC105	1.5 mL tube	1
	Enrichment Amplification Mix	GC106	0.5 mL tube	1

Note: The Evercode BCR Mega kit ECIB1500 (Human) includes the following boxes: HBG100, HBG200, and HBG400.



The Evercode BCR Mega kit ECIB1510 (Mouse) includes the following boxes: MBG100, MBG200, and MBG400.

The Evercode BCR Mega kit ECIB1520 (Transgenic Mouse) includes the following boxes: MBG100, MBG200, and MBG500.

-20°C Sample Dilution Accessory Kit* Store at -20°C, PN ECAC3901

LABEL	ITEM	PN	FORMAT	QTY
	Sample Dilution Buffer	MG105	2 mL tube	3

*The -20°C Sample Dilution Accessory Kit is optional and can be purchased separately if needed to dilute concentrated samples.

Parse-Provided Equipment

The following is a list of equipment provided by Parse Biosciences, required to successfully perform the Evercode workflows on the INTEGRA ASSIST PLUS.

The equipment listed should be stored at -20°C when not in use and taken out when instructed throughout the protocol.

ITEM	PN	QTY
Thermochromic PCR Cold Block	NTAC1102	3
Thermochromic PCR Cold Block Riser	NTAC1103	3
Parse Metal Cold Block	NTAC1107	1

INTEGRA Components

The following are required INTEGRA ASSIST PLUS components needed to run the Evercode assay on the INTEGRA ASSIST PLUS and should not be substituted.

ITEM	ITEM TYPE	PN	QTY
Pipette Communication Module for VIAFLO / VOYAGER Pipettes	Accessory	4222	3
ASSIST PLUS Slanted Plate Holder (0°-30°)	Adapter	4510	1
Tip Deck for D-ONE Pipetting Module	Base	4535	1
Dual Reservoir Adapter (ANSI/SLAS footprint)	Adapter	4547	1
ASSIST PLUS Labware Pedestal (+24 mm) for D-ONE, portrait, for 10 mL, 25 mL, 100 mL, reservoirs and plates/reservoirs in SLAS/ANSI format (24 mm Labware Pedestal)	Adapter	4551	1
D-ONE Pipetting Module 1-Ch, 5-1250 µL	Pipette	4532	1
VIAFLO Pipette 12-Ch, 5-125 µL	Pipette	4632	1
VOYAGER Pipette 8-Channel, 5 - 125 µL	Pipette	4722	1
ASSIST PLUS Base Unit	Main	4505	1
Communication/Charging Cable for VIAFLO	Accessory	4226	1
HEATMAG module	Module	4901	1
96 Well Adapter for HEATMAG module	Adapter	4906	1

Consumables and Reagents

The following is a list of consumables and reagents required to successfully perform Parse Evercode workflows on the INTEGRA ASSIST PLUS.

INTEGRA Consumables

ITEM	PN	QTY
25 mL Basin Reservoir Liner	4316	7
8 Row Polystyrene Reservoir	6373	1
300 mL Reservoir Bases	6305	1
1250 µL Pipette Tips	6545	as needed
125 µL Pipette Tips	6565	

Other Consumables

ITEM	SUPPLIER	PN	QTY
Sterilized 25 µm, 40 µm, or 70 µm Mini Cell Strainer	DiagnoCine	FNK-HT-AMS-12502 FNK-HT-AMS-14002 FNK-HT-AMS-17002	2
10 mL Transport Tube	GlobeScientific™	6102S	3
1.5 mL Microtube	Genesee Scientific	21-257	4
PCR Strip Tubes	USA Scientific®	1402-4700	8
2 mL Microtubes	Genesee Scientific	21-255	3
Semi-skirted 96 well plates	Eppendorf®	E951020362	3
SealPlate®	Excel Scientific	100-SEAL-PLT	as needed
Pipette Tips TR LTS 20 µL, 200 µL, 1000 µL	Rainin®	17014961 17014963 17014967	as needed

Reagents

ITEM	SUPPLIER	PN	NOTES
AMPure® XP Reagent	Beckman Coulter®	A63880 (5 mL) A63881 (60 mL)	Choose one. We do not recommend substituting other magnetic beads.
SPRIselect Reagent	Beckman Coulter	B23317 (5mL) B23318 (60mL)	
KAPA® Pure Beads	Roche®	KK8000 (5 mL) KK8001 (30mL)	
Pipette Tips TR LTS 20 µL, 200 µL, 1000 µL	Rainin®	17014961 17014963 17014967	Or appropriate DNA low-binding, DNase/RNase-free, and filtered pipette tips. Do not use wide bore tips.
RNaseZap™ RNase Decontamination Solution	Thermo Fisher Scientific®	AM9780	Or equivalent RNase decontamination solution.
Ethyl alcohol, Pure	Sigma-Aldrich®	459844	Or equivalent 100% non-denatured ethanol.
Nuclease-Free Water	Sigma-Aldrich	W4502	Or equivalent nuclease-free water.
Trypan Blue	Various Suppliers	Varies	Or alternative dyes to assess cell viability, such as AO/PI.
Qubit dsDNA HS (High Sensitivity) Assay Kit	Thermo Fisher Scientific	Q33230 (100 assays) Q33231 (500 assays)	Or equivalent DNA quantifier.
High Sensitivity DNA Kit	Agilent®	5067-4626	Choose one that corresponds to the chosen Bioanalyzer or TapeStation.
High Sensitivity D5000 ScreenTape and Reagents	Agilent	5067-5592 (screen tape) 5067-5593 (sample buffer and ladder)	

Equipment

The following equipment is required to perform the protocol, but are not provided by INTEGRA or by Parse Biosciences. Note that this list does not include standard laboratory equipment, such as freezers.

Equipment

ITEM	SUPPLIER	PN	NOTES
Centrifuge with Swinging Bucket Rotors	Various Suppliers	Varies	Compatible with 96 well plates and capable of reaching 4°C.
Microcentrifuge	Various Suppliers	Varies	Compatible with 1.5 mL tubes.
Hemocytometer	Sigma-Aldrich®	Z359629	Or other cell counting devices. We recommend validating alternatives relative to a hemocytometer.
Plate Seal Applicator	Various Suppliers	Varies	Capable of adhering plate sealing films to 96 well plates.
T100 Thermal Cycler	Bio-Rad Laboratories®	1861096	Or an equivalent thermocycler compatible with semi-skirted 96 well plates, 0.2mL PCR tubes with up to 100 µL of sample volume, sample heating and cooling from 4-98°C, and a heated lid capable of 30-105°C.
Water bath	Various Suppliers	Varies	Or equivalent thermomixer, heat block, or bead bath capable of holding temperature at 37°C.
Vortex-Genie 2®	Scientific Industries®	SI-0236	Or alternative vortex and adapter for 96 well plates, or a thermomixer or alternative shaker that can be set to 800-1000 RPM.
6-inch Platform	Scientific Industries	146-6005-00	
Microplate Foam Insert	Scientific Industries	504-0235-00	
Qubit™ Flex Fluorometer	Thermo Fisher Scientific	Q33327	Or an equivalent fluorometer.
2100 Bioanalyzer	Agilent®	G2939BA	Choose one.
4200 TapeStation System	Agilent	G2991BA	

Reading and Understanding Visuals and Diagrams

Understanding the figures in this user manual is essential for accurately interpreting the information presented.

While the figures are different, they share consistent formats, use standardized visual elements and follow common conventions.

There are three types of figures in this manual.

- Photos of the hardware configurations, including tip rack, and Decks A, B, and C.
- Visual representation of Decks A, B, and C where consumable labware, reagents, and samples are placed.
- Diagrams of the pipette illustrating the steps to select the appropriate program.

We recommend reviewing this section and the illustrations throughout the manual to familiarize yourself with the visual language used.

Understanding the Hardware Configurations

The hardware configurations appear at the beginning of each subsection and show how to set up the INTEGRA platform to complete the associated steps. This photo displays the tip racks, Deck A, Deck B, and Deck C. Red arrows indicate the order in which tips are picked up by the INTEGRA platform, and required hardware is highlighted with text boxes.

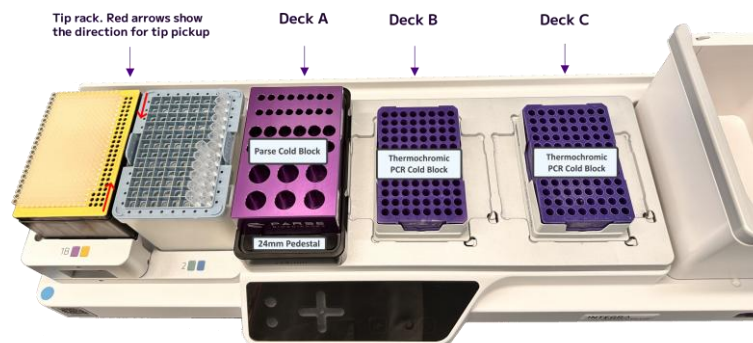

Blocks and Pedestals are hardware components that will be placed or removed as needed throughout the workflow.

Reading and Understanding the Deck Configurations

Each subsection includes multiple deck configurations that illustrate the steps executed by the program. These configurations display the exact placement of reagents and samples on the decks, list the consumables required at each step, and highlight pipette prompts for manual intervention.

Graphical representation of basins and/or tubes with colored outlines show where specific reagents will be added. Each outline color matches the color of the reagent's label.

Color-coded cues guide the user through actions such as loading, moving, or removing hardware, reagents, and consumables, while also indicating the specific deck locations where these actions should occur.

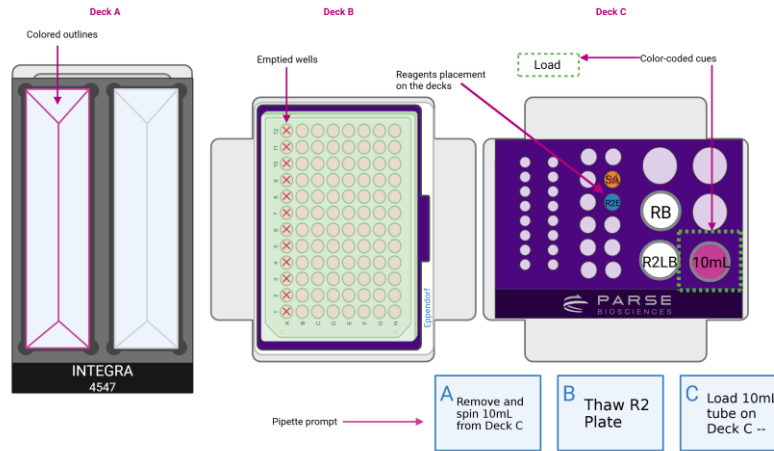

The Parse Metal Cold Block

It is critical to place reagents, samples, and consumables in the correct positions on the Parse Metal Cold Block.

The Parse Metal Cold Block is organized into three main columns, 1, 2 and 3, each containing two sub-columns (left and right) with slots of varying sizes to accommodate different tube types.

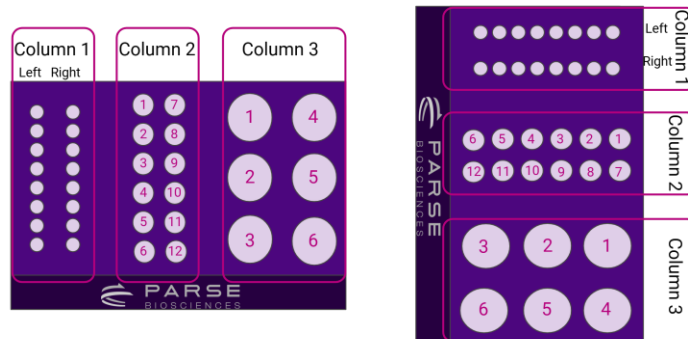

Color-Coded Cues

This workflow is semi-automated and still requires user interaction and input. Prompts will appear on the pipette display, instructing the user to perform tasks such as loading, moving, removing, or replacing hardware, reagents, and consumables, as well as mixing and pipetting

specific reagents. In this user guide, each prompt is color-coded and shown in the deck configurations illustrating the required actions. Additional explanatory text accompanies each figure to provide further detail on the steps involved.



- **Load:** Indicates labware and/or reagents that need be placed or reloaded onto the deck.
- **Remove:** Identifies labware that should be taken off the deck, either for incubation, disposal, or because it is not needed in the upcoming step.
- **Replace:** Highlights labware that has been used and needs to be swapped out for clean or new consumables.
- **Pipette:** Prompts the user to manually dispense reagents into designated basins.
- **Mix:** Instructs the user to mix specific reagents.
- **Move:** Indicates labware that should be relocated between deck positions.
- **X Emptied:** Reminds that the content has been used and the vessel is now empty.



Note: The position of the color-coded cues on top of the figures does not necessarily correspond to the location where the action should be taken.

Pipette Programs Diagram

At various points in the procedure, the user will need to switch pipettes and tip racks. In each subsection, the pipette is pre-programmed to carry out specific tasks defined by a designated script. The correct program must be loaded onto the pipette before beginning each set of steps. A diagram showing the path to load the appropriate program is provided in every subsection.

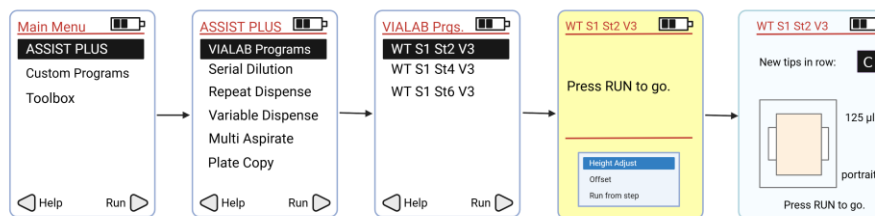

Section 1: Automation Setup & In Situ Barcoding

1.1. Sample Normalization

Prior to setting up the Automation workflow, count the cells to assess quality and concentration of the fixed sample(s). Samples should be diluted with Sample Dilution Buffer to the target concentrations listed in the Sample Loading Table.

After adjusting the sample(s) to the recommended dilution range, update the Sample Loading Table, and download the Sample Loading Table macro (Section 1.1.4). This .csv file will be used as reference for allocating the fixed cells into the 96-well PCR Dilution Plate, to prepare samples to be loaded into the Barcoding Round 1 Plate. The recommended dilution range for WT Mega is 2,125-8,000 cells per μL .

The program uses the sample dilution buffer on Deck A to normalize fixed samples from plate format on Deck C into an intermediate dilution plate on Deck B.

1. Cool a centrifuge with swinging bucket rotors to 4°C
2. Set a water bath to 37°C.
3. Gather the following components and reagents:

ITEM	SOURCE	QTY	HANDLING AND STORAGE
D-ONE Pipetting Module 1-Ch, 5-1250 μL	INTEGRA Component	1	
Tip Deck for D-ONE Pipetting Module	INTEGRA Component	1	
125 μL Tip Rack	INTEGRA	1	
1250 μL Tip Rack	INTEGRA	1	
24 mm Labware Pedestal	INTEGRA Component	1	
Thermochromic PCR Cold Block	Parse	2	Pull the Thermochromic PCR Cold Block with riser from the -20°C freezer and leave them at room temperature for 10 minutes prior to use.
Thermochromic PCR Cold Block Riser	Parse	2	
Parse Metal Cold Block	Parse	1	Keep on ice when not in use.
Semi-Skirted 96 Well PCR Plate	Consumables	2	

ITEM	SOURCE	QTY	HANDLING AND STORAGE
● Sample Dilution Buffer	-20°C Reagents or ECAC3901	1	Thaw at room temperature then store on ice. Mix by inverting 3x.
Round 1 Plate	-20°C Reagents	1	Place directly on ice.

4. Download the Parse Biosciences Evercode WT INTEGRA Mega Sample Loading Table. The most current version of the Evercode WT INTEGRA Mega Sample Loading Table can be found on the Parse Biosciences [Customer Support Suite](#). Customer log-in is required to access the Sample Loading Table.
5. Thaw the previously fixed cells samples in a water bath set to 37°C until all ice crystals dissolve. Thoroughly mix each sample by pipetting and store on ice.
6. If not done beforehand, count the number of cells with an automated cell counter or alternative cell counting device. Record the cell count. This will be used to fill out the Sample Loading Table in section 1.1.7d.
7. Fill the Sample Loading Table tab of the worksheet.
 - a. Per the instructions in the worksheet, input number of samples (Figure 1).



Note: For more information on using the Sample Loading Table, see the "Important Guidelines" section of the User Guide.

This sheet should be filled out prior to starting Section 1.

Step	Instructions
1	Ensure Macros are enabled.
2	Input the number of samples.
3	Input the target number of barcoded cells. Note: The default is 1,000,000 cells for Evercode WT Mega.
4	Input your sample names.
5	Input the target percentage representation of each sample in the final library. CRITICAL: No percentage can be lower than 1.05%.
If not already done, count the samples as described in Section 1.1 of the Evercode WT Mega User Manual.	
6	Input stock cell concentration for each sample.
7	Open the "Integra Loading Table" sheet and load the samples in the appropriate wells and volumes using a semi-skirted plate.
8	CRITICAL: Ensure that Sample Dilution Buffer is completely thawed before use.
9	Open the "Diluent Volumes" sheet. Click on the "Generate a Worklist for Import into VIALAB" to generate the worklist file.
10	Open the "Sample Volumes" sheet. Click on the "Generate a Worklist for Import into VIALAB" to generate the worklist file.

Number of Samples (Step 2): **CRITICAL:** We do not recommend editing cells highlighted in grey.

Target Number Barcoded Cells (Step 3):

Sample #	Sample Name (Step 4)	Percent of Library (Step 5)	Stock Concentration (cells/uL) (Step 6)	Number of Wells	Targeted Number of Barcoded Cells	Required Sample Concentration (cells/uL)
1	Sample A	40.00%	3,000	38	400000	2148
2	Sample B	35.00%	2,750	34	350000	2100
3	Sample C	25.00%	2,500	24	250000	2125
TOTALS:		100.00%		96	1,000,000	

Figure 1: Evercode WT Mega Sample Loading Table.

- b. Enter Target Number of Barcoded Cells, Sample Name, Percent of Library and Stock Concentration for corresponding samples. Errors and possible solutions can be found in Appendix C (Figure 2).



Note: If any parameter is out of range, the cells will turn pink in color and/or an error message will appear (Figure 2). Be sure to address and adjust worksheet input values appropriately before continuing.

This sheet should be filled out prior to starting Section 1.

Step	Instructions
1	Ensure Macros are enabled.
2	Input the number of samples.
3	Input the target number of barcoded cells. Note: The default is 100,000 cells for Evercode WT.
4	Input your sample names.
5	Input the target percentage representation of each sample in the final library. CRITICAL: No percentage can be lower than 2.09%. If not already done, count the samples as described in Section 1.1 of the Evercode WT User Manual.
6	Input stock cell concentration for each sample.
7	Prepare the dilutions as described. CRITICAL: Ensure that Sample Dilution Buffer is completely thawed before use.
8	Open the "Plate Configuration" sheet. With the plate on ice, add 14 μ L of each diluted sample to the appropriate well(s) of the Round 1 Plate as shown in the plate map. CRITICAL: Follow the instructions in the User Guide with respect to sample mixing and changing tips.

Number of Samples (Step 2): **CRITICAL:** We do not recommend editing cells highlighted in grey.

Target Number Barcoded Cells (Step 3):

Sample #	Sample Name (Step 4)	Percent of Library (Step 5)	Stock Concentration (cells/ μ L) (Step 6)	Number of Wells	Targeted Number of Barcoded Cells	Required Sample Concentration (cells/ μ L)
1		100.00%	5,000	48	1000000	5203
TOTALS:		100.00%		48	1,000,000	

CRITICAL: This cell stock concentration is too low.

Figure 2: Example error message, noting that the sample stock concentration is too low.

- c. Navigate to the "INTEGRA Loading Table" tab. If the "Required Number of Sample Dilution Tubes" is greater than 1, three additional dilution buffer tubes for highly concentrated samples can be purchased as a Sample Dilution Accessory Kit (see "Sample Concentrations" in Important Guidelines) (Figure 3).

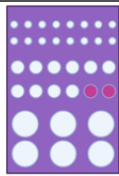

Note: Example: Sample 1 is loaded into Sample Location A1 and Sample Location A2 with a minimum volume of 131 μ L. More sample volume (up to a maximum of 200 μ L total sample volume) can be loaded to reduce bubbles during mixing.

Sample Name	Sample Location	Min Sample Stock Needed for Dilution (μ L)	*Note: due to semi-skirted plate volumes, multiple wells might be needed for the same samples.	Min Diluent Needed (μ L)	Required Number of Sample Dilution Tubes	Sample Dilution Tube Locations
Sample 1	A1	131.0		1955.0	2	
Sample 1	A2	131.0				
Sample 2	A3	84.0				
Sample 3	A4	84.0				
Sample 4	A5	84.0				
	A6					
	A7					
	A8					
	A9					
	A10					
	A11					
	A12					
	B1					
	B2					

EXTRA SAMPLE DILUTION TUBES REQUIRED TO COMPLETE INTEGRA SAMPLE NORMALIZATION

Figure 3: INTEGRA Loading Table tab noting Minimum Diluent Needed and Sample Locations.

- d. Referring to the "INTEGRA Loading Table" tab, manually load fixed samples into the directed "Sample Location" well into a new Eppendorf semi-skirted plate. Note that any individual sample may require loading into more than one "Sample Location" well. This is the sample stock plate. Store the sample stock plate on ice for later use.
- e. Navigate to the "Diluent Volumes" tab and click on the purple box labeled "Generate a Worklist for Import into VIALAB". Save the generated CSV file

(called "CombinedMegaWorksheet_YYYYMMDD_HHMMSS.csv") for later use (Figure 4).

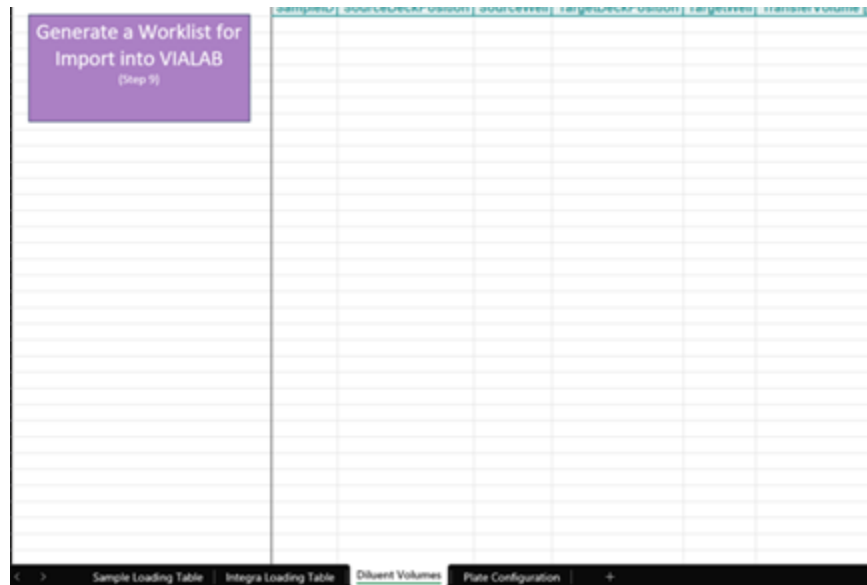

Figure 4: Diluent Buffer Volumes tab for generating a VIALAB worklist.

- f. Navigate to the "Plate Configuration" tab to visualize the final sample location within the 96 well plate format (Figure 5).

Evercode WT Round 1 Barcoding Plate Configuration

- For more details on using this Sample Loading Table, see the Important Guidelines section of the User Manual

Use the following plate layout to load samples into the Round 1 Plate in Section 1.2.

	1	2	3	4	5	6	7	8	9	10	11	12
A	1	1	1	1	1	1	1	1	1	1	1	1
B	1	1	1	1	1	1	1	1	1	1	1	1
C	2	2	2	2	2	2	2	2	2	2	2	2
D	2	2	2	2	2	2	2	2	2	2	2	2
E	3	3	3	3	3	3	3	3	3	3	3	3
F	3	3	3	3	3	3	3	3	3	3	3	3
G	4'	4'	4'	4'	4'	4'	4'	4'	4'	4'	4'	4'
H	4'	4'	4'	4'	4'	4'	4'	4'	4'	4'	4'	4'

Sample Number	Sample Name	Percent Contributing
1		100.00%

Figure 5: Plate Configuration tab visualizes the sample locations.

8. Import the generated CSV files into VIALAB to be uploaded on the pipettes.
 - a. Open the VIALAB program **MG S1 St1 DONE V3_5** and navigate to the "Method" section.



CRITICAL! Delete any previous S1 St1 scripts from the D-ONE pipette to avoid running incorrect scripts.

- b. In the "O2 Worklist", under the "Worklist and Volumes" tab, upload the "CombinedMegaWorksheet_YYYYMMDD_HHMMSS.csv" worklist file generated in Step 7e using the "Import" button (Figure 6).

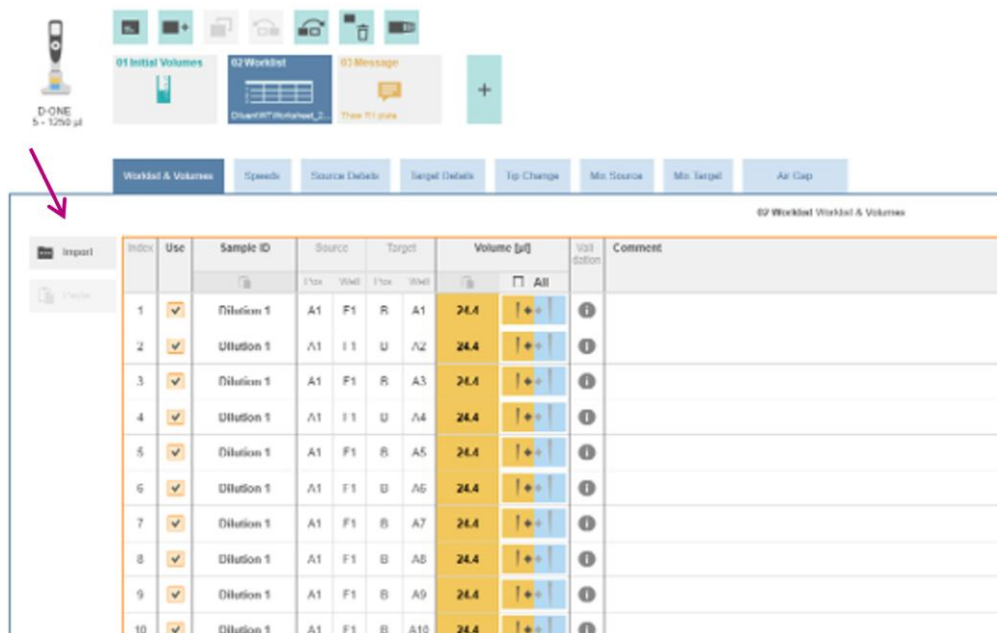
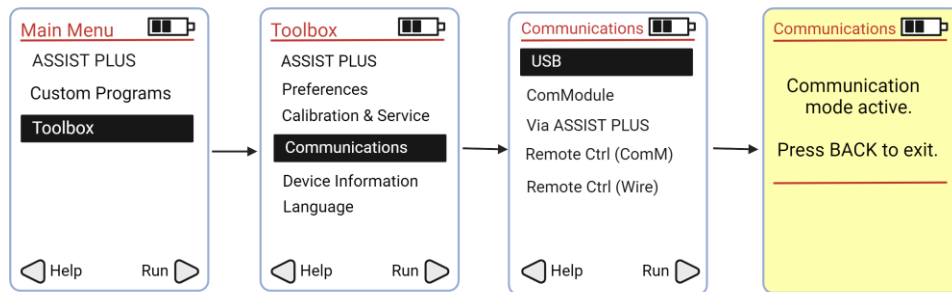
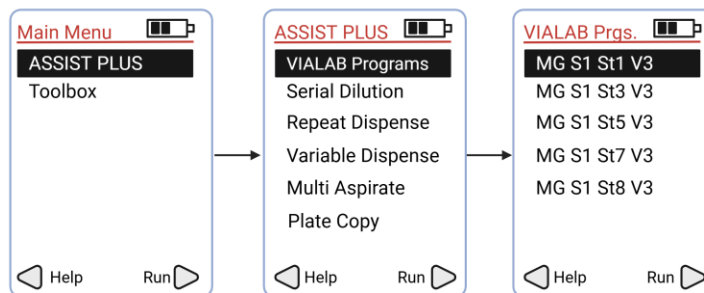

Figure 6: VIALAB worklist generation for diluent volumes using O2 Worklist.

9. Save and transfer your program to your D-ONE Pipetting Module (1-Ch, 5-1250 μ L) as follows, ensuring that any program previously uploaded on the pipette is deleted:
 - a. Connect your computer with D-ONE Pipette using Communication/Charging Cable for VIAFLO.
 - b. Follow the instructions on the pipette menu, as shown in the diagram below:



- c. Select the "Transfer" tab in the opened **MG S1 St1 DONE V3_5** VIALAB program.
- d. Confirm that the pipette has been recognized by the software. Click "Send to pipette". An audible signal will indicate the successful upload of the **MG S1 St1 V3_5** program to the D-ONE Pipette.
- e. Disconnect the cable and proceed with the protocol on the INTEGRA ASSIST PLUS platform.
- f. If done correctly, a program named **MG S1 St1 V3_5** will be found on your pipette as shown in the diagram below.



10. Set up the deck following the Deck Configuration below.

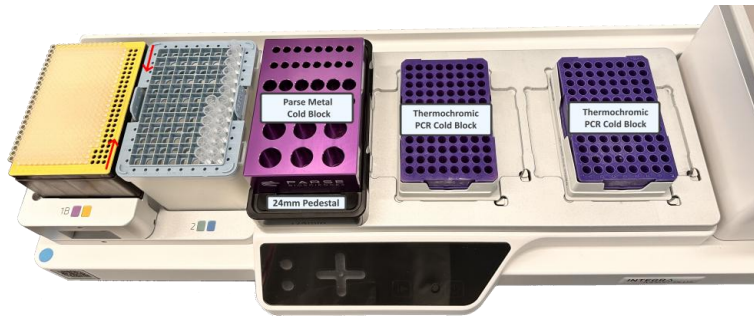

11. Load the following reagents and consumables to their respective positions on Decks A, B and C:

- a. Deck A, column 2
 - i. Pos 7: ● Sample Dilution Buffer.
- b. Deck B: a clean semi-skirted plate on Deck B with A1 corner in the bottom left.
- c. Deck C: Sample plate with A1 corner in the bottom left.

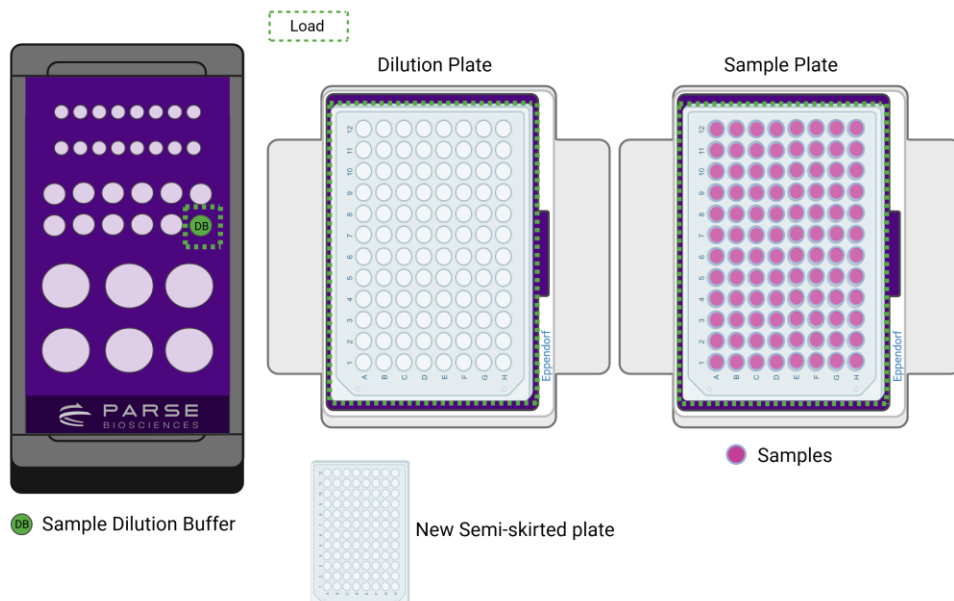

12. Attach D-ONE Pipetting Module 1-Ch, 5-1250 µL and the corresponding Tip Deck.

- a. Remove the reagent caps, then select and run the program **MG S1 St1 V3_5**. Ensure the Tip Deck and Tip Boxes are securely positioned by pressing them down firmly until they click into place.

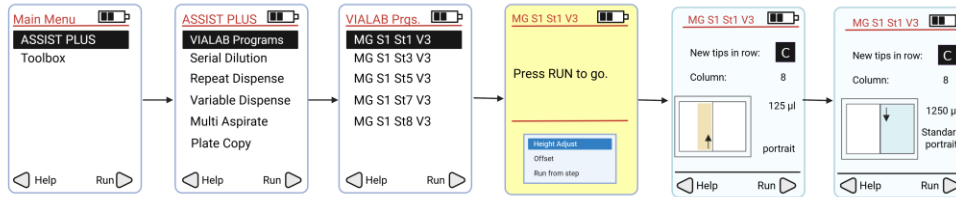

13. During the run, but after the ● Sample Dilution Buffer has been dispensed:

- a. Thaw the Round 1 Plate using the following thermocycling program. Remove a Thermochromic PCR Cold Block to thaw at room temperature during the following thermocycling program.

THAW ROUND 1 PLATE		
Run Time	Lid Temperature	Sample Volume
10 min	70°C	26 µL
Step	Time	Temperature
1	10 min	25°C
2	Hold	4°C

- b. At the completion of the thermocycler program, centrifuge the Round 1 Plate for **1 minute** at 100 x g at 4°C.

14. At the conclusion of the run:

- a. Store any remaining Sample Dilution Buffer from Deck A on ice. Remove all labware from Deck A.
- b. Keep all the labware, including the Diluted Sample Plate on Deck B. This will be used in the next step.
- c. Remove all the hardware on Deck C. Discard the used Sample Plate on Deck C.

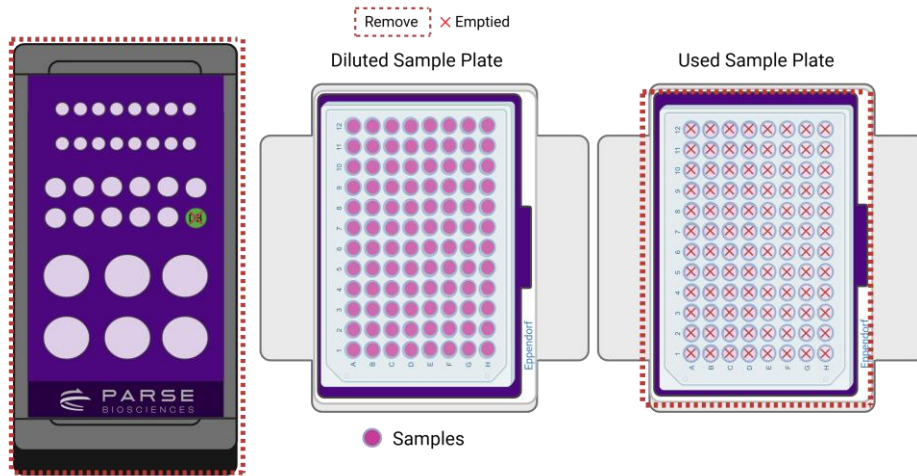

1.2. Load and Pool Round 1

The program loads the normalized cells on Deck B into the Round 1 Plate on Deck C. After Barcoding Round 1 incubation, move the Round 1 Plate onto Deck B.

The program then pools all the samples in the Round 1 Plate into rows A and E.

To load the sample(s):

1. Gather the following components and reagents:

ITEM	SOURCE	QTY	HANDLING AND STORAGE
VIAFLO Pipette 12-Ch, 5-125 µL	INTEGRA Component	1	
Tip Deck for VIAFLO Pipette 12-Ch, 5-125 µL	INTEGRA Component	1	
5-125 µL Tip Rack	INTEGRA	1	
Thermochromic PCR Cold Block	Parse	1	If not done earlier, pull the Thermochromic PCR Cold Block with riser from the -20°C freezer and leave them at room temperature for 10 minutes prior to use.
Thermochromic PCR Cold Block Riser	Parse	1	

2. Place the Thermochromic PCR Cold Block with Thermochromic PCR Cold Block Riser that was thawed during the previous step on Deck C following the configuration below.



3. While secured in a PCR plate rack on a flat surface, remove the plate seal from the Round 1 Plate and place on Deck C with A1 at the bottom left. The diluted sample plate is still on Deck B with A1 at the bottom left.

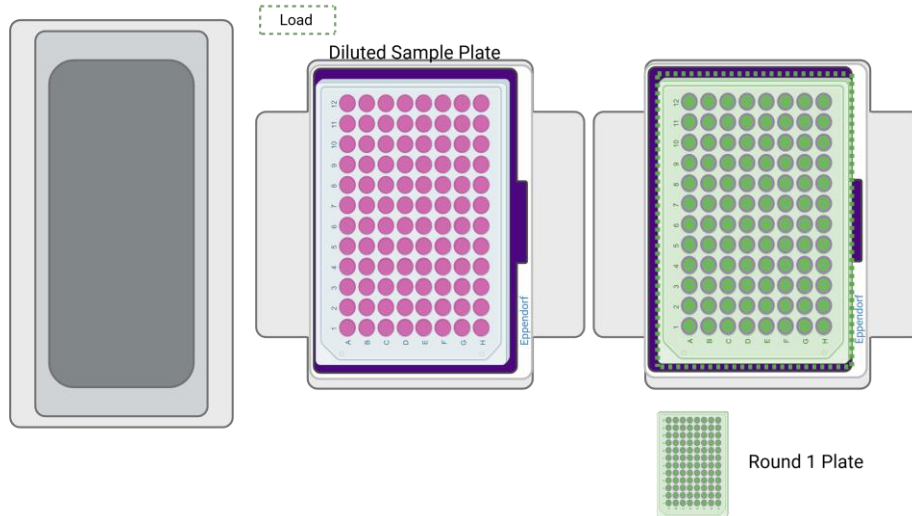

4. Change the pipette that is connected to the INTEGRA ASSIST PLUS:
 - a. Remove D-ONE Pipetting Module 1-Ch, 5-1250 μ L and corresponding Tip Deck. Ensure it is disconnected by pressing the back button until the main menu is displayed.
 - b. Replace it with VIAFLO 12-Ch 5-125 μ L Pipette and corresponding Tip Deck. Ensure the Tip Deck and Tip Box are securely positioned by pressing them down firmly until they click into place. Remove the tip box lid prior to starting the program.
5. Run the program **MG S1 St2 V3_5** following the diagram below.

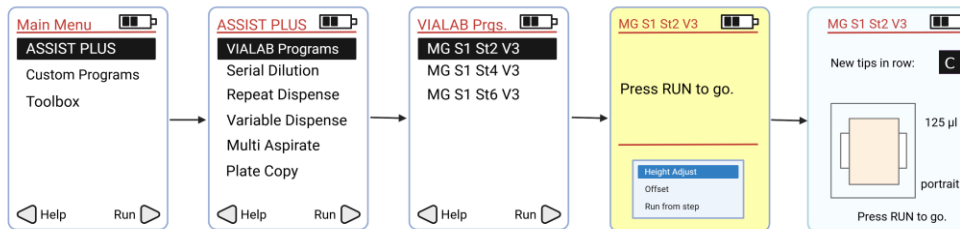

6. Press “Run” to continue the program. Follow the program prompts for manual intervention:

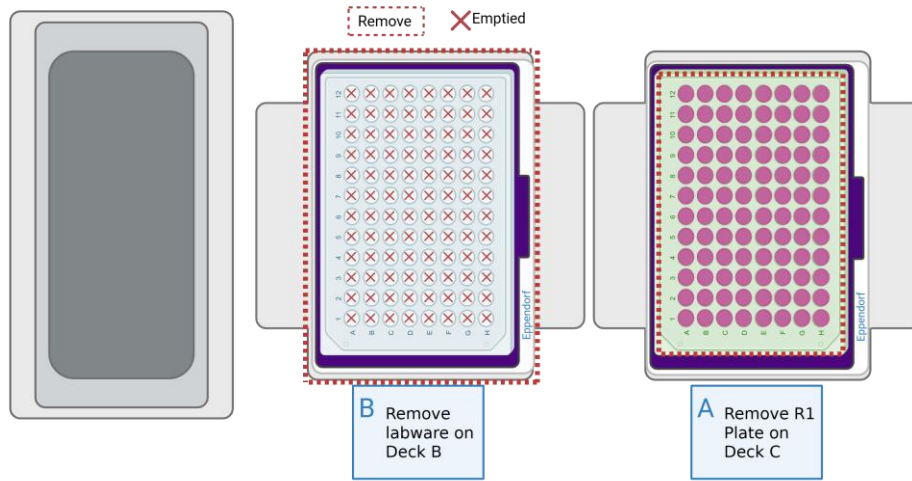

- a. Remove and seal the Round 1 Plate from Deck C using the Plate Seal Applicator. Place the Round 1 Plate into a thermocycler and run the following program.

BARCODING ROUND 1			
Run Time	Lid Temperature	Sample Volume	
40 min	70°C	40 µL	
Step	Time	Temperature	Cycles
1	10 min	50°C	1
2	12 s	8°C	3
3	45 s	15°C	
4	45 s	20°C	
5	30 s	30°C	
6	2 min	42°C	
7	3 min	50°C	1
8	5 min	50°C	
9	Hold	4°C	Hold

- b. Remove and discard the now empty diluted sample plate on Deck B. Remove the Thermochromic PCR Cold Block located on Deck B and store it upside down in the freezer for future use.

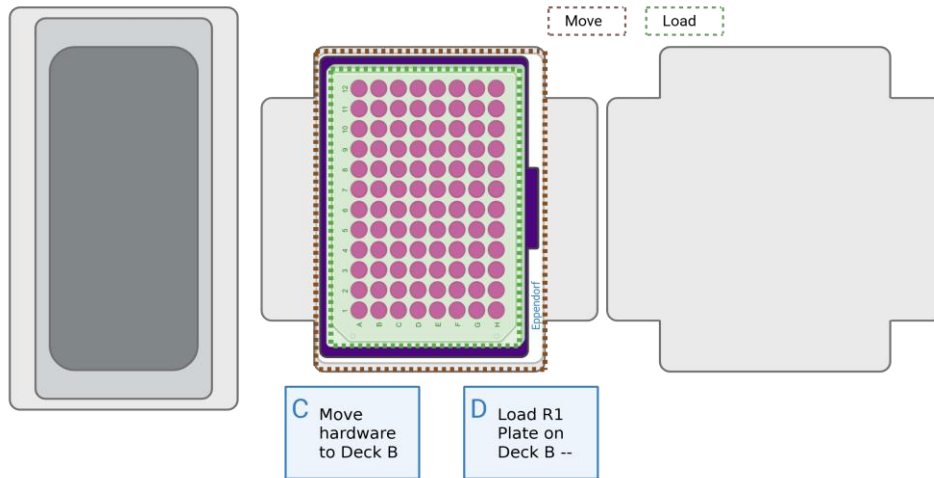

- c. Move the ThermoChromic PCR Cold Block that was on Deck C to Deck B.
- d. When the Barcoding Round 1 Thermocycling program is complete, load the Round 1 plate on the ThermoChromic PCR Cold Block on Deck B. Press "Run" to continue the program.

7. At the conclusion of the run:

- a. The sample should be pooled into rows A and E of the Round 1 plate. Do not remove the labware on Deck B. This will be used in the next step.

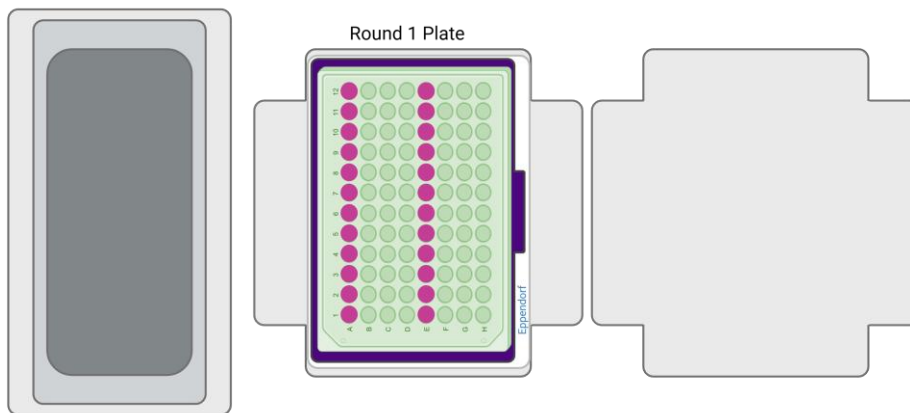

1.3. Round 2 Ligation Preparation

The program pools all the samples from the plate on Deck B into a 10 mL tube on Deck C. After centrifugation, the program removes supernatant and resuspends the cells in Resuspension Buffer. The program mixes Round 2 Ligation Enzyme and Round 2 Ligation Buffer with the resuspended cells. The cells are then put on the left basin on Deck A.

1. Gather the following components and reagents:

ITEM	SOURCE	QTY	HANDLING AND STORAGE
D-ONE Pipetting Module 1-Ch, 5-1250 μ L	INTEGRA Components	1	
Thermochromic PCR Cold Block	Parse	1	Pull the Thermochromic PCR Cold Block with riser from the -20°C freezer and leave them at room temperature for 10 minutes prior to use.
Thermochromic PCR Cold Block Riser	Parse	1	
Parse Metal Cold Block	Parse	1	Keep on ice when not in use.
Tip Deck for D-ONE Pipetting Module	INTEGRA Components	1	
125 μ L Tip Rack	INTEGRA	1	
1250 μ L Tip Rack	INTEGRA	1	
10 mL transport tube	Consumables	1	
Dual Reservoir Adapter	INTEGRA Components	1	
25 mL Basin Reservoir Liners	INTEGRA	2	
Round 2 Plate	-20°C Reagents	1	Place directly on ice.
● Round 2 Ligation Enzyme	-20°C Reagents	1	Place directly on ice. Briefly centrifuge before use.
○ Round 2 Ligation Buffer	-20°C Reagents	1	Thaw at room temperature then store on ice. Mix by inverting 3x.
○ Resuspension Buffer	-20°C Reagents	1	
● Spin Additive	4°C Reagents	1	Briefly centrifuge. Keep at room temperature.
● Round 2 Stop Buffer	-20°C Reagents	1	Thaw at room temperature then store on ice until use in Section 1.4. Mix by vortexing before using.

2. Place the Dual Reservoir Adapter on Deck A.
3. Place the Parse Metal Cold Block on Deck C. The deck should correspond to the configuration below.

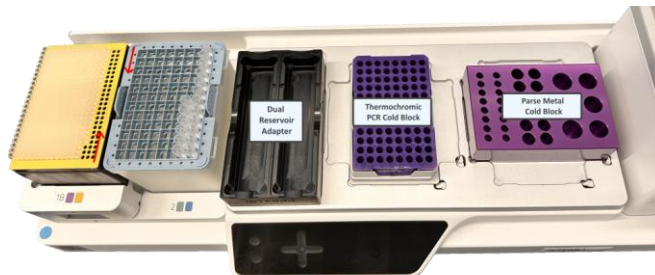

4. Load the following reagents and consumables to their respective positions on Deck A and on the Parse Metal Cold Block on Deck C.
 - a. On Deck A: two clean basin liners.
 - b. On Deck B: Round 1 Plate.
 - c. On Deck C, in the Parse Metal Cold Block:
 - i. Column 2:
 1. Pos 8: ● Spin Additive.
 2. Pos 9: ● Round 2 Ligation Enzyme.
 - ii. Column 3:
 1. Pos 2: ○ Resuspension Buffer.
 2. Pos 3: ○ Round 2 Ligation Buffer.
 3. Pos 6: a 10 mL transport tube.

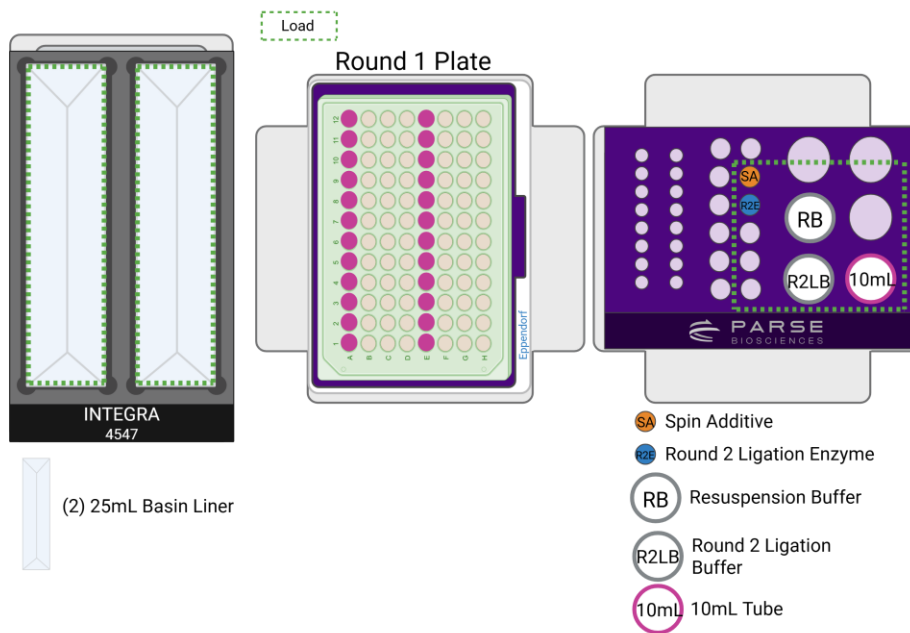

5. Change the pipette that is connected to the INTEGRA ASSIST PLUS:
 - a. Remove the VIAFLO 12-Ch 5-125 μL pipette and corresponding tip deck. Ensure it is disconnected by pressing the back button until the main menu is displayed.
 - b. Replace it with the D-ONE Pipetting Module 1-Ch, 5-1250 μL pipette and corresponding tip deck. Ensure the tip deck and tip boxes are securely positioned by pressing them down firmly until they click into place. Remove the tip box lids prior to starting the program.
6. Remove the reagent caps, then run the program **MG S1 St3 V3_5** following the diagram below.

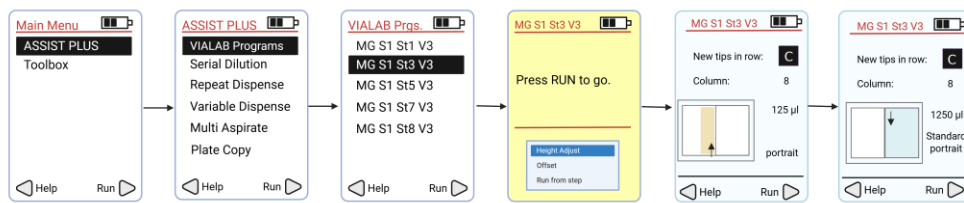

7. Press "Run" to continue the program. Follow the program prompts for manual intervention:

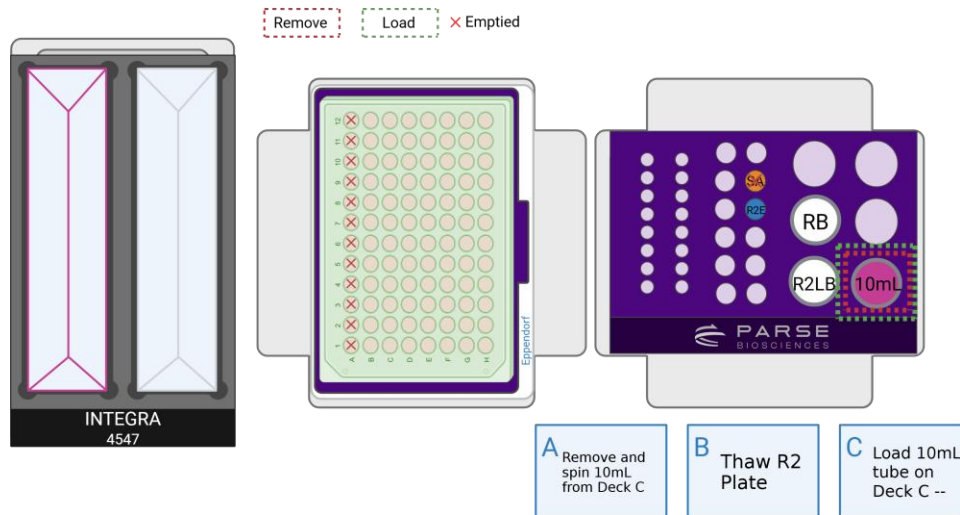

- a. Before removing for centrifugation, cap and invert once the 10 mL transport tube containing the pooled cells in column 3, position 6. Centrifuge the sample in a swinging bucket centrifuge cooled to 4°C for **10 minutes** at 250-500 x g.

- b. Thaw the Round 2 Plate using the program below for later use. While the program is still running, remove a frozen ThermoChromic PCR Cold Block with Riser from -20°C freezer and thaw at room temperature for later use.

THAW ROUND 2 PLATE		
Run Time	Lid Temperature	Sample Volume
10 min	70°C	10 µL
Step	Time	Temperature
1	10 min	25°C
2	Hold	4°C

- c. Once centrifugation is complete, remove the cap from the 10 mL transport tube and place it back in its original position within the Parse Metal Cold Block located on Deck C, position 6. Press "Run" to continue. The program will remove the supernatant, add the Resuspension Buffer, and the Round 2 Ligation Buffer.

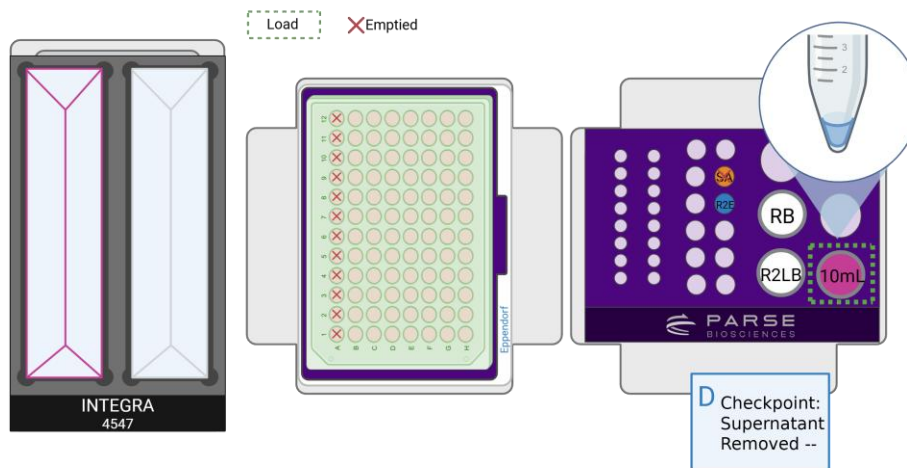

- d. Check the 10 mL tube after the supernatant removal steps. There should be remaining volume at the bottom of the 10 mL tube. The cell pellet may or may not be visible at this step.



CRITICAL! Return the 10 mL transport tube to the Parse Metal Cold Block immediately after centrifugation. Handle the tube with care to avoid jostling or disturbing the pellet. If the pellet becomes resuspended prior to supernatant removal, it may lead to loss of cells.

8. At the conclusion of the run:

- a. Keep all the labware on Deck A. The sample is in the left basin liner on Deck A. Do not discard this. It will be used in the next step. Replace the right basin liner on Deck A with a clean 25 mL reservoir liner.
- i. Remove all labware from Deck B. Discard the used Round 1 Plate. Remove the Thermochromic PCR Cold Block located on Deck B and store it in the freezer for future use.
- j. Store the ● Spin Additive at room temperature. Do not discard it as it will be used for a future step. Discard other used tubes. Remove the hardware on Deck C.

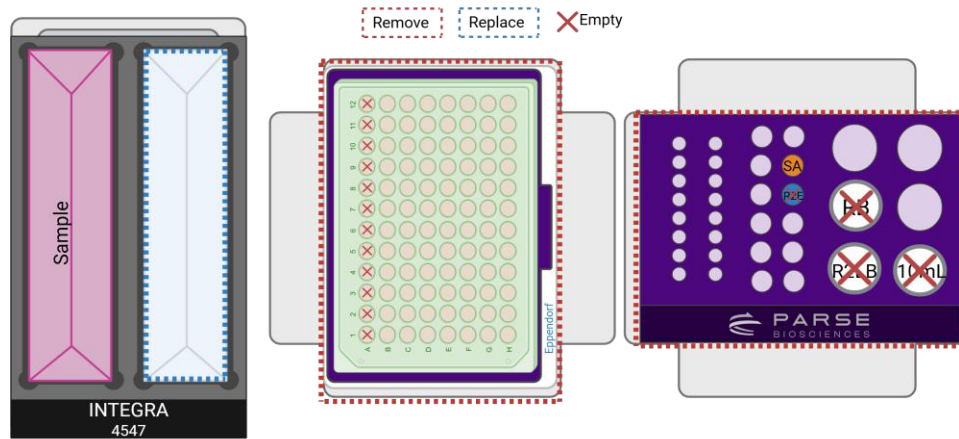

1.4. Round 2 Ligation

The program transfers the sample from the left reservoir on Deck A to Round 2 Plate on Deck B. Following Round 2 Incubation, the program will load Round 2 Stop Buffer in the right reservoir into each well. After Round 2 Stop incubation, it pools all samples together in the left reservoir on Deck A.

1. Gather the following items and handle as indicated below:

ITEM	SOURCE	QTY	HANDLING AND STORAGE
VIAFLO Pipette 12-Ch, 5-125 μ L	INTEGRA Components	1	
Tip Deck for VIAFLO Pipette 12-Ch, 5-125 μ L	INTEGRA Components	1	
125 μ L Tip Rack	INTEGRA	1	
Thermochromic PCR Cold Block	Parse	1	Pull the Thermochromic PCR Cold Block with riser from the -20°C freezer and leave them at room temperature for 10 minutes prior to use.
Thermochromic PCR Cold Block Riser	Parse	1	
INTEGRA Dual 25mL Basin Reservoir Adapter	INTEGRA	1	
25 mL Basin Reservoir Liners	INTEGRA	2	

2. Place the Thermochromic PCR Cold Block with Thermochromic PCR Cold Block Riser removed from the freezer in step 1.3.7b on Deck B.

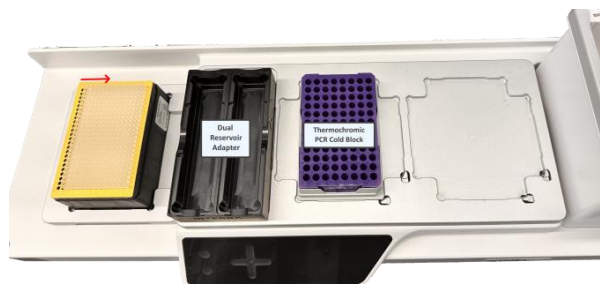

3. While secured in a PCR plate rack on a flat surface, remove the plate seal from the Round 2 Plate and place on Deck B with A1 at the bottom left.

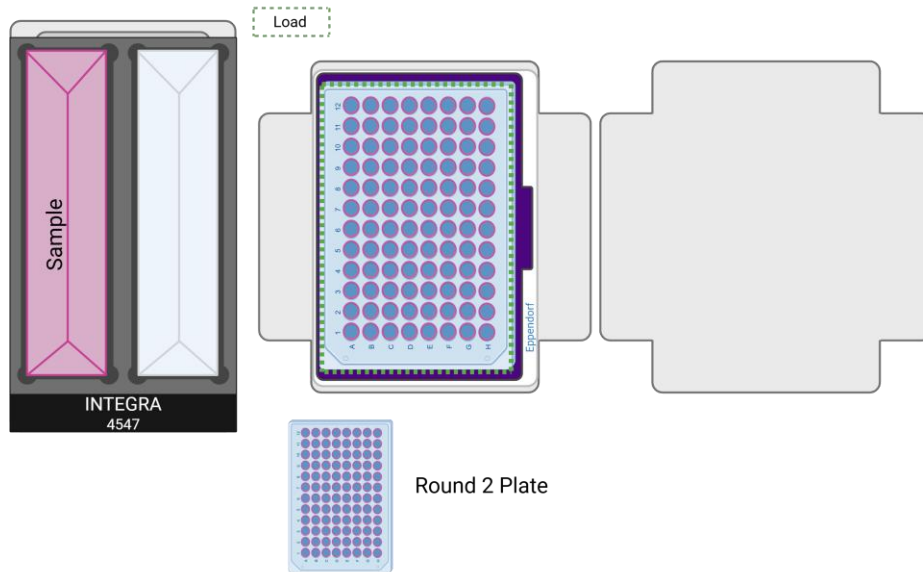

4. Change the pipette that is connected to the INTEGRA ASSIST PLUS:
 - a. Remove the D-ONE Pipetting Module 1-Ch, 5-1250 μ L pipette and corresponding tip deck. Ensure it is disconnected by pressing the back button until the main menu is displayed.
 - b. Replace it with the VIAFLO 12-Ch 5-125 μ L pipette and corresponding tip deck. Ensure the tip deck and tip box are securely positioned by pressing them down firmly until they click into place. Remove the tip box lid prior to starting the program.
5. Run the program **MG S1 St4 V3_5** following the diagram below.

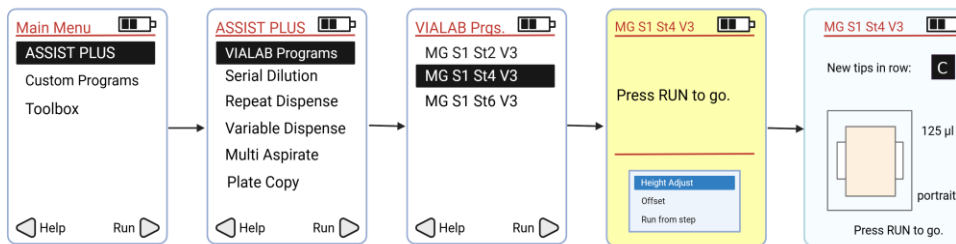

6. Press “Run” on the program to continue. Follow the program prompts for manual intervention:

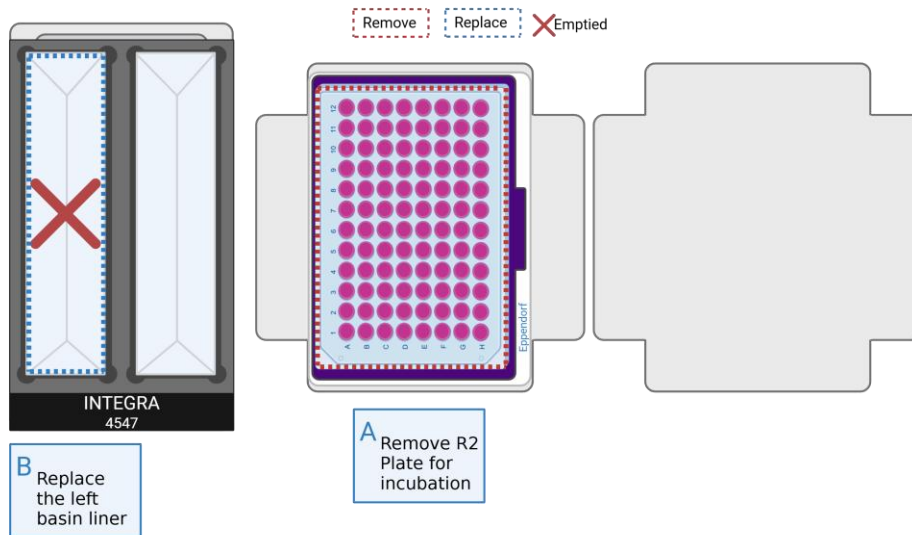

Note: If the volume is still insufficient to fill every well, a few can be left empty without impacting experimental results.

- a. Remove the Round 2 Plate from Deck B. Reseal the Round 2 Plate with an adhesive seal, place it into a thermocycler, and run the following program.

BARCODING ROUND 2		
Run Time	Lid Temperature	Sample Volume
15 min	50°C	50 µL
Step	Time	Temperature
1	15 min	16°C
2	Hold	4°C

- b. Replace the used left basin liner with a clean 25 mL basin reservoir liner.

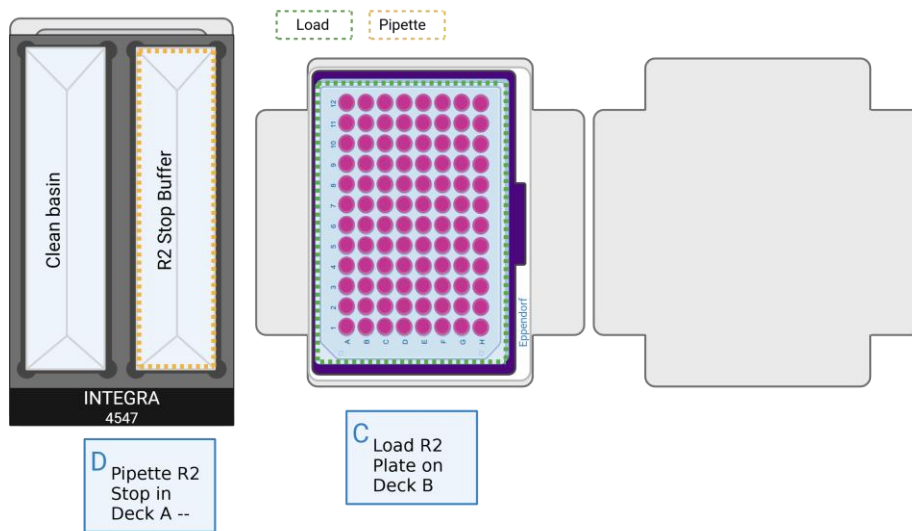

- c. When the Barcoding Round 2 Thermocycling program is complete, load the Round 2 Plate on the Thermochromic PCR Cold Block on Deck B with A1 oriented towards the lower left corner.
- d. Briefly vortex (2-3 seconds) and centrifuge the ● Round 2 Stop Buffer. Pipette the total volume (~1.4 mL) to the right basin on Deck A with a P1000 set to 1000 μ L. Disperse the liquid to ensure it is even across the basin.

7. Press “Run” to continue the program. Follow the program prompts to complete the program:

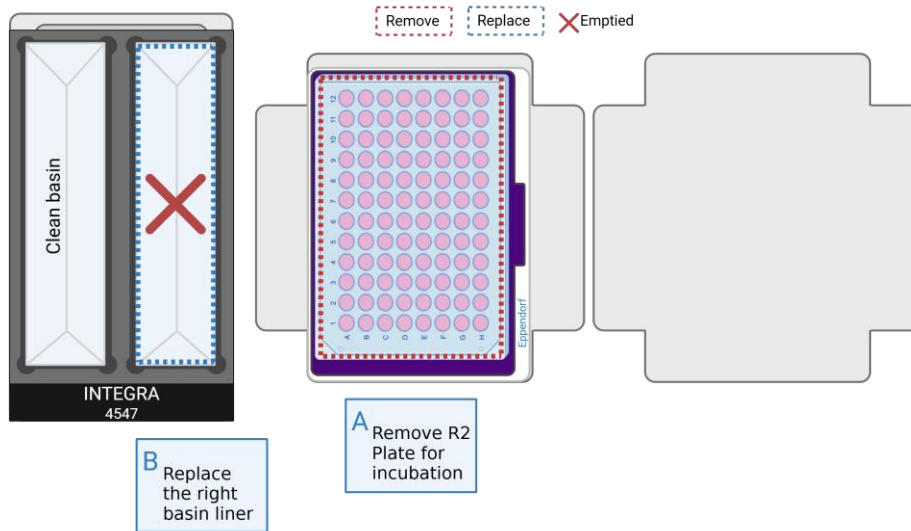

- a. Remove the Round 2 Plate from Deck B. Reseal the Round 2 Plate with an adhesive seal, and incubate the Round 2 Plate in a thermocycler using the following protocol.

ROUND 2 STOP		
Run Time	Lid Temperature	Sample Volume
5 min	50°C	60 µL
Step	Time	Temperature
1	5 min	16°C
2	Hold	4°C

- b. Replace the used right basin liner with a clean 25 mL basin reservoir liner.

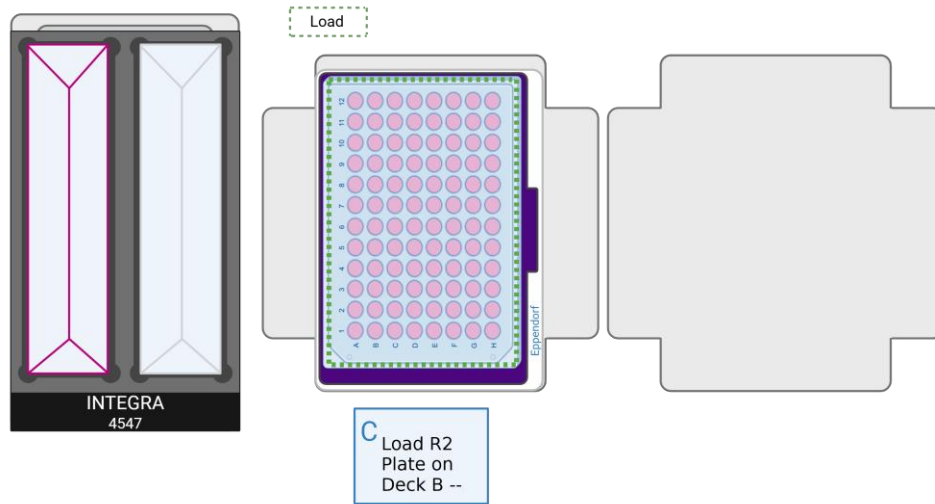

- c. When the Barcoding Round 2 Stop Thermocycling program is complete, load the Round 2 plate on the Thermochromic PCR Cold Block on Deck B with A1 oriented towards the lower left corner. Remove the plate seal before continuing the program.
8. At the completion of the run:
- a. Keep all the labware on Deck A. The sample is in the left basin liner on Deck A. Do not discard this. It will be used in the next step.
 - b. Remove all labware from Deck B. Discard the used Round 2 Plate. Remove the Thermochromic PCR Cold Block located on Deck B and store it upside down in the freezer.

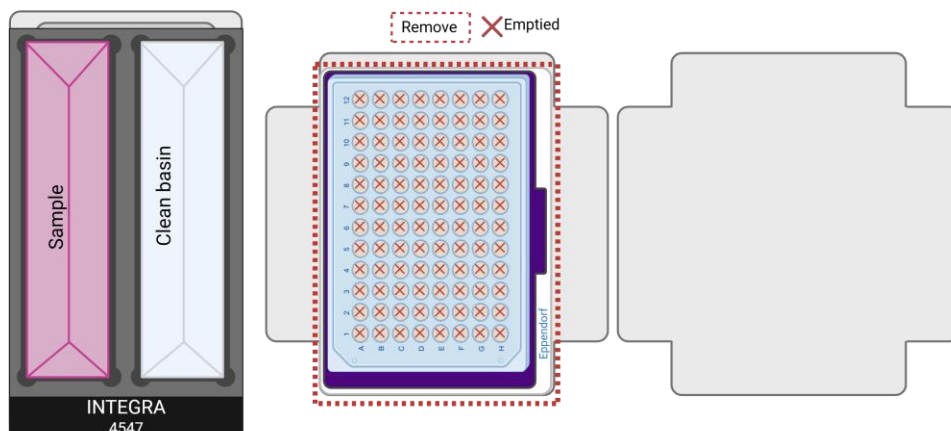

1.5. Round 3 Ligation Preparation

The pooled cell suspension in the left reservoir on Deck A is strained into the 10 mL transport tube on Deck C. The program adds Round 3 Ligation Enzyme into the cells and mixes. It then transfers the cell suspension mix to the top reservoir within the slanted plate holder on Deck B.

1. Gather the following components and reagents:

ITEM	SOURCE	QTY	HANDLING AND STORAGE
D-ONE Pipetting Module 1-Ch, 5-1250 µL	INTEGRA Component	1	
Tip Deck for D-ONE Pipetting Module	INTEGRA Component	1	
Parse Metal Cold Block	Parse-Provided	1	Keep on ice when not in use.
Dual Reservoir Adapter (ANSI/SLAS footprint)	INTEGRA Component	1	
ASSIST PLUS Slanted Plate Holder	INTEGRA Component	1	
10 mL transport tube	Consumables	1	
25 mL Basin Reservoir Liners	INTEGRA	2	
25 µm, 40 µm, or 70 µm cell strainer	Consumables	1	
125 µL Tip Rack	INTEGRA	1	
1250 µL Tip Rack	INTEGRA	1	
Round 3 Plate	-20°C Reagents	1	Place directly on ice.
● Round 3 Ligation Enzyme	-20°C Reagents	1	Place directly on ice. Briefly centrifuge before use.

2. Place the ASSIST PLUS Slanted Plate Holder set to 10° on Deck B. The lower end should be on the left.

3. Place the Parse Metal Cold Block on Deck C. Deck layout should correspond to the configuration below.



4. Load the following reagents to their respective positions on the Parse Metal Cold Block on Deck C.
 - a. Column 2:
 - i. pos 10: ● Round 3 Ligation Enzyme.
 - b. Column 3:
 - i. pos 6: a clean 10 mL transportation tube.

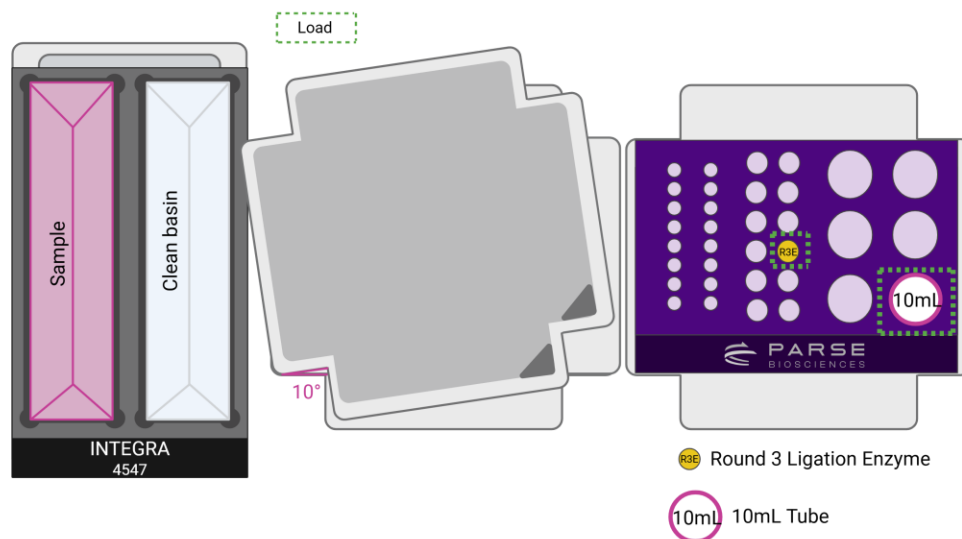

5. Change the pipette that is connected to the INTEGRA ASSIST PLUS:
 - a. Remove the VIAFLO 12-Ch 5-125 μ L pipette and corresponding tip deck. Ensure it is disconnected by pressing the back button until the main menu is displayed.
 - b. Replace it with the D-ONE Pipetting Module 1-Ch, 5-1250 μ L pipette and corresponding tip deck. Ensure the tip deck and tip boxes are securely positioned by pressing them down firmly until they click into place. Remove the tip box lids prior to starting the program.

- Remove the reagent caps, then select and run the program **MG S1 St5 V3_5** following the diagram below.

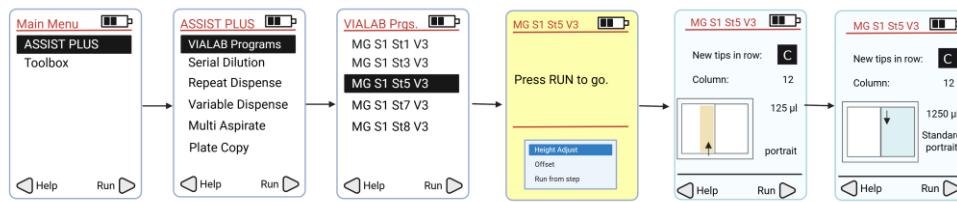

- Press "Run" to continue the program. Follow the program prompts for manual intervention to move the basin as indicated below:

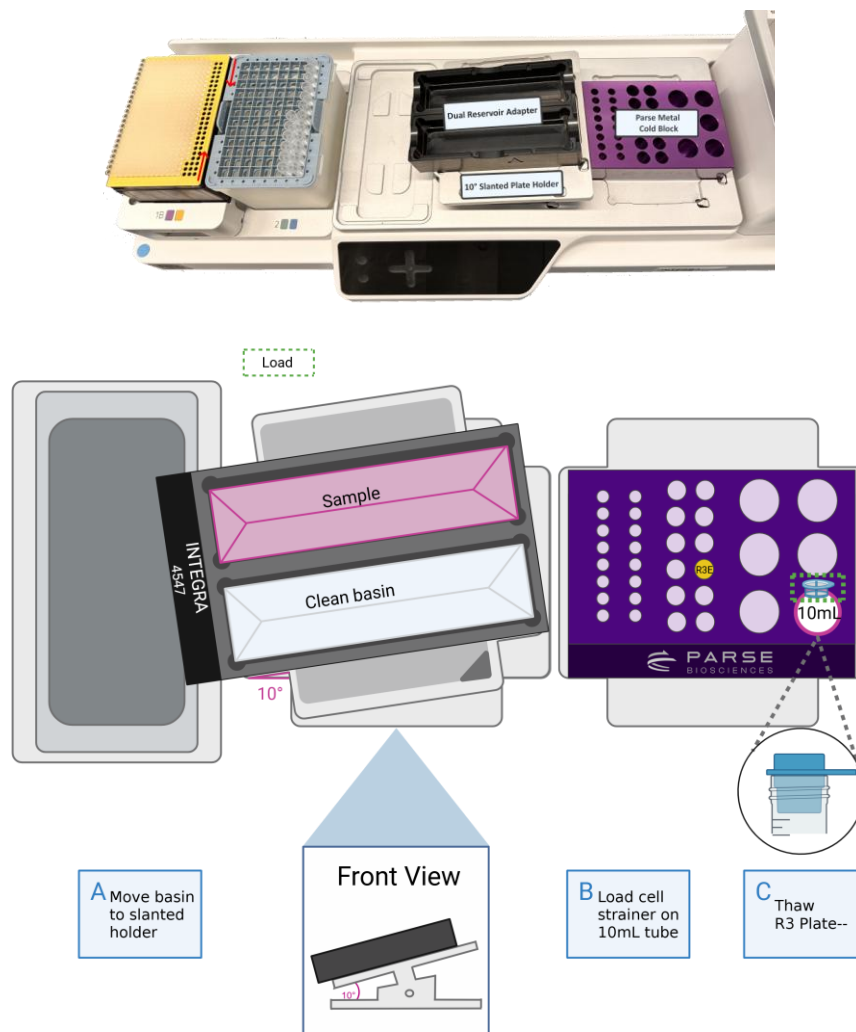

Note: When moving the dual reservoir adapter onto the slanted plate holder on Deck B, take extra care when moving the sample to avoid spills.

- a. Move the Dual Reservoir Adapter with the sample from Deck A to the slanted plate holder on Deck B. The INTEGRA logo at the front of the Dual Reservoir Adapter faces towards the pipette tip box. The sample should now be located on the top reservoir of the Dual Reservoir Adapter.
- b. Load a cell strainer so it sits inside of the 10 mL transport tube.
- c. Thaw the Parse Round 3 Plate using the program below for later use. While the thermocycling program is running, remove a new ThermoChromic PCR Cold Block with Riser from -20°C freezer and thaw at room temperature and continue to the next step.

THAW ROUND 3 PLATE		
Run Time	Lid Temperature	Sample Volume
10 min	70°C	10 µL
Step	Time	Temperature
1	10 min	25°C
2	Hold	4°C

8. Press "Run" to continue the program. Follow the program prompts to complete the program:

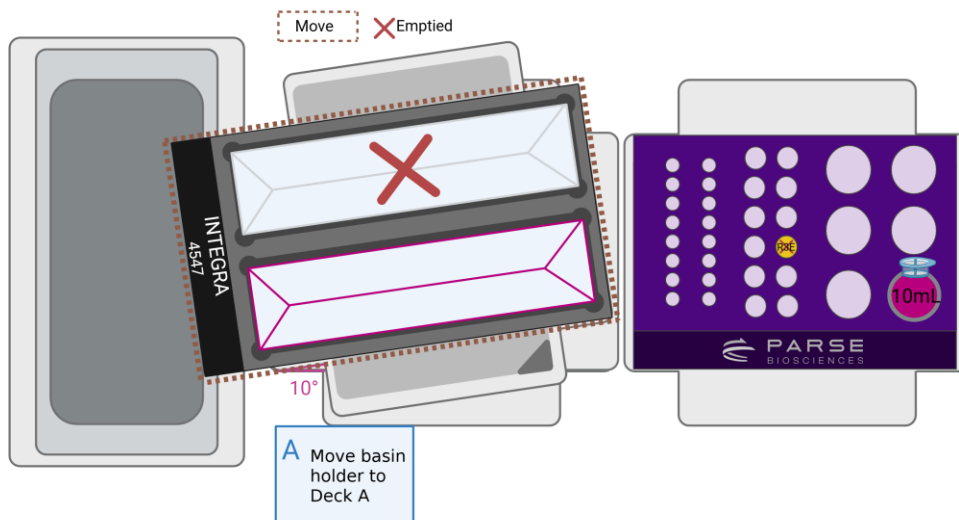

- a. Move the Dual Reservoir adapter to Deck A. Ensure that the INTEGRA logo is facing the front.

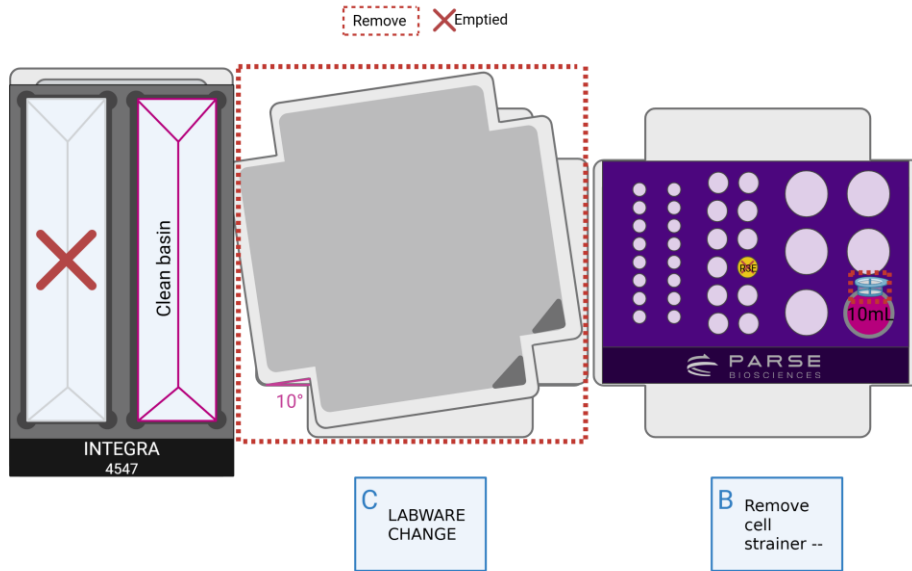

b. Remove the used cell strainer from the 10 mL transport tube on Deck C.



Note: There may be bubbles left on the strainer. This will not affect the results.

c. Remove Slanted Plate Holder from Deck B.

9. Press "Run" to continue the program. At the completion of the run:

- a. Keep all labware on Deck A. The sample is in the right basin liner on Deck A. Do not discard this. It will be used in the next step.
- b. Remove all labware from Deck C. Discard all used tubes on Deck C.

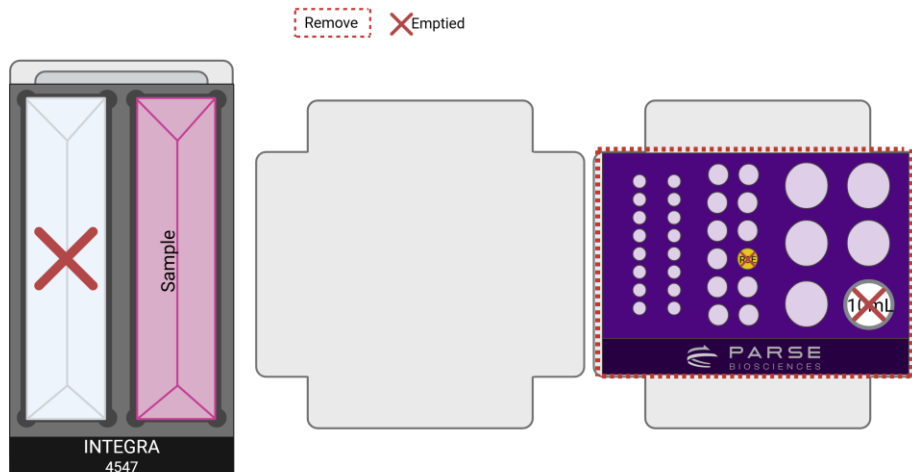

1.6. Round 3 Ligation

The program loads the Cell Suspension Mix on Deck A into the Round 3 Plate on Deck B. Following the prompts for Round 3 incubation, the program will then load Round 3 Stop Buffer into all the wells and pool all the samples together on Deck A.

1. Gather the following components and reagents:

ITEM	SOURCE	QTY	HANDLING AND STORAGE
VIAFLO Pipette 12-Ch, 5-125 μ L	INTEGRA Component	1	
Tip Deck for VIAFLO Pipette 12-Ch, 5-125 μ L	INTEGRA Component	1	
Thermochromic PCR Cold Block	Parse	1	Pull the Thermochromic PCR Cold Block with riser from the -20°C freezer and leave them at room temperature for 10 minutes prior to use.
Thermochromic PCR Cold Block Riser	Parse	1	
INTEGRA Dual 25mL Basin Reservoir Adapter	INTEGRA Component	1	
25 mL Basin Reservoir Liners	INTEGRA	2	
25 μ m, 40 μ m, or 70 μ m cell strainer	Consumables	1	
125 μ L Tip Rack	INTEGRA	1	
○ Round 3 Stop Buffer	-20°C Reagents	1	Thaw at room temperature then store on ice. Mix by vortexing.

2. Place the Thermochromic PCR Cold Block with Riser removed from the freezer in step 1.5.7c on Deck B. Deck layout should correspond to the configuration below.



3. While secured in a PCR plate rack on a flat surface, remove the plate seal from the Round 3 Plate and place on Deck B with A1 at the bottom left.

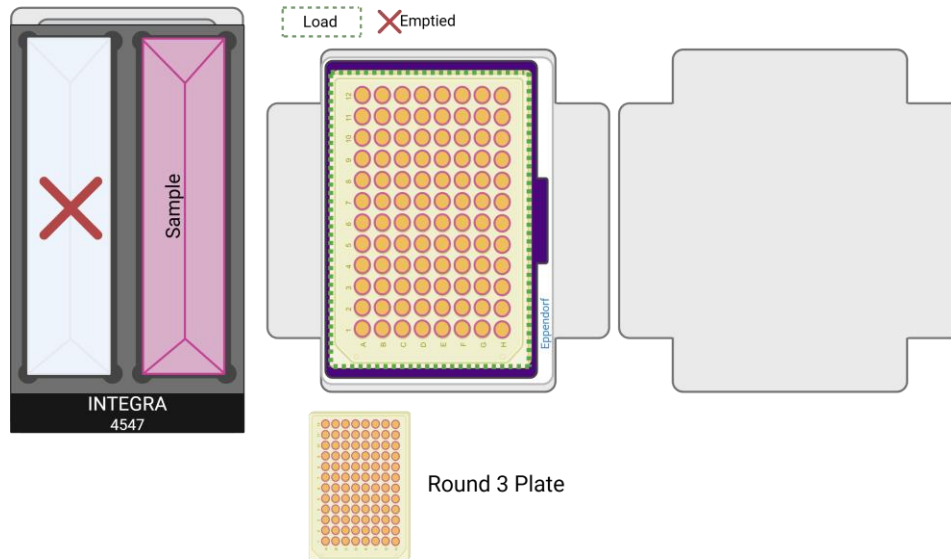

4. Change the pipette that is connected to the INTEGRA ASSIST PLUS:
 - a. Remove the D-ONE Pipetting Module 1-Ch, 5-1250 μL pipette and corresponding tip deck. Ensure it is disconnected by pressing the back button until the main menu is displayed.
 - b. Replace it with the VIAFLO 12-Ch 5-125 μL pipette and corresponding tip deck. Ensure the tip deck and tip box are securely positioned by pressing them down firmly until they click into place. Remove the tip box lid prior to starting the program.
5. Run the program **MG S1 St6 V3_5** following the diagram below.

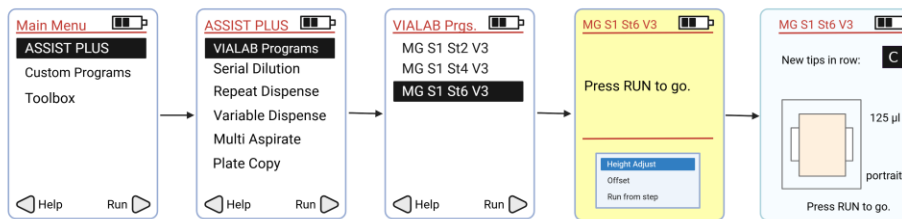

6. Press “Run” to continue the program. Follow the program prompts for manual intervention:

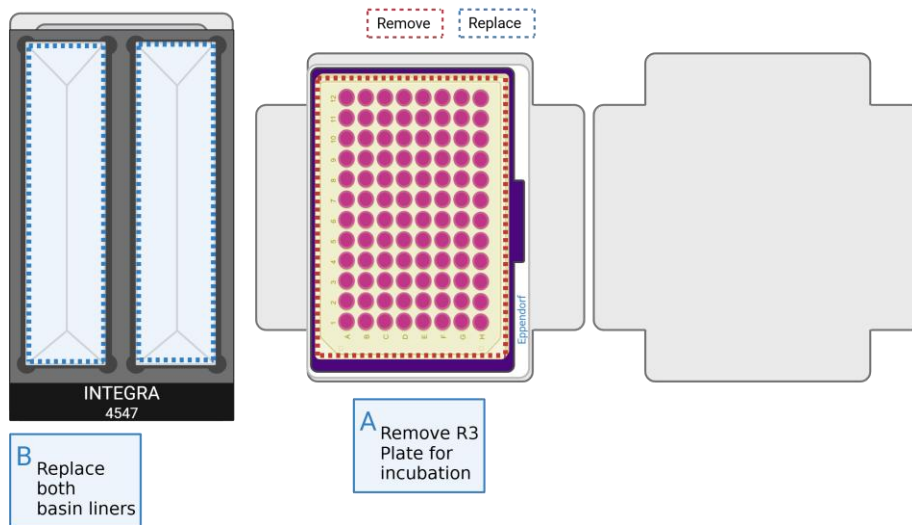

a. Remove the Round 3 Plate from Deck B. Reseal the Round 3 Plate with an adhesive seal, place it into a thermocycler, and run the following program.

BARCODING ROUND 3		
Run Time	Lid Temperature	Sample Volume
15 min	50°C	60 µL
Step	Time	Temperature
1	15 min	16°C
2	Hold	4°C

b. Replace both used basin liners on Deck A with clean 25 mL basin reservoir liners.

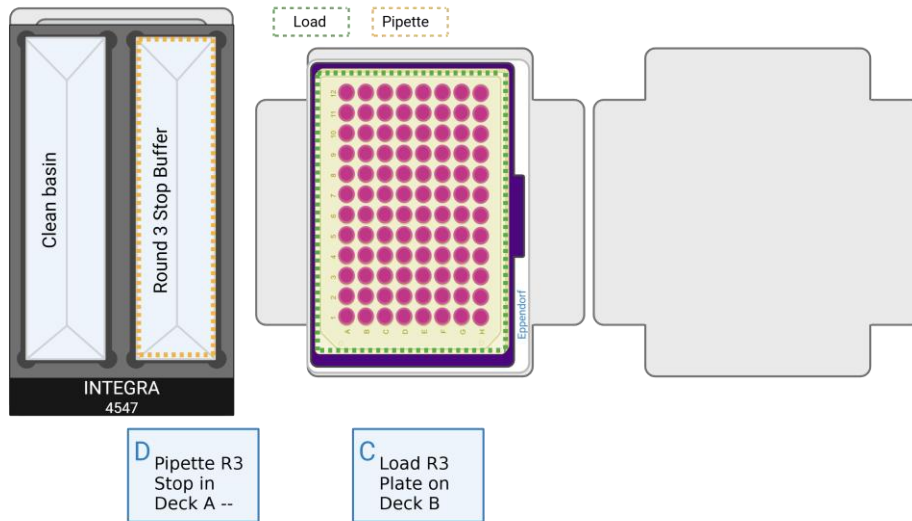

- c. When the Barcoding Round 3 Thermocycling program is complete, load the Round 3 plate on the Thermochromic PCR Cold Block on Deck B with A1 oriented towards the lower left corner.
- d. Briefly vortex (2-3 seconds) the Round 3 Stop Buffer and ensure there is no precipitate. Pipette the total volume (~3.5 mL) to the right basin on Deck A using a P1000 set to 1000 μ L.

7. At the completion of the run:

- a. Keep all the labware on Deck A. The sample is in the left basin liner on Deck A. Do not discard this. It will be used in the next step.
- b. Remove all labware from Deck B. Discard the used Round 3 Plate. Remove the Thermochromic PCR Cold Block located on Deck B and store it in the freezer.

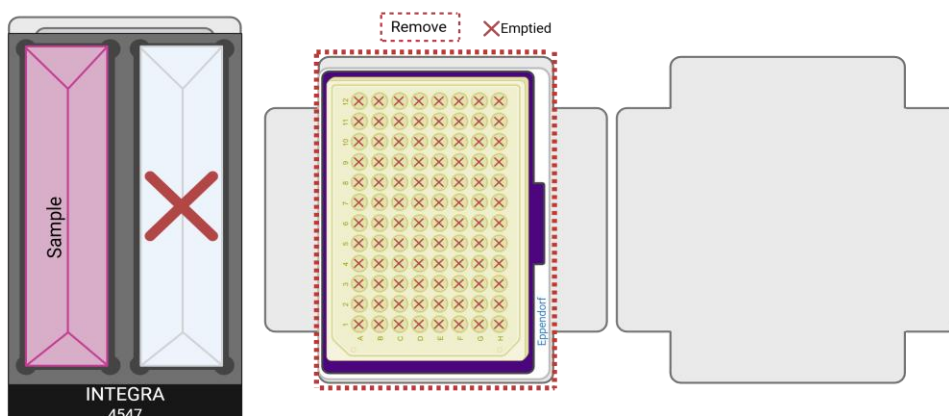

1.7. Pre-Lysis

The pooled cell suspension on Deck B is strained into the 10 mL transport tube on Deck C. The Spin Additive is then added into the cells and centrifuged. Supernatant is removed; the cells are resuspended in Pre Lysis Wash Buffer, and centrifuged again. The supernatant is then removed.

1. Gather the following components and reagents:

ITEM	SOURCE	QTY	HANDLING AND STORAGE
D-ONE Pipetting Module 1-Ch, 5-1250 µL	INTEGRA Components	1	
Tip Deck for D-ONE Pipetting Module	INTEGRA Components	1	
Parse Metal Cold Block	Parse	1	Keep on ice when not in use.
ASSIST PLUS Slanted Plate Holder	INTEGRA Components	1	
Dual 25mL Basin Reservoir Adapter	INTEGRA Components	1	
10 mL transport tube	Consumables	1	
25 mL basin reservoir liners	INTEGRA	2	
25 µm, 40 µm, or 70 µm cell strainer	Consumables	1	
125 µL Tip Rack	INTEGRA	1	
1250 µL Tip Rack	INTEGRA	1	
● Spin Additive	4°C Reagents	1	Keep at room temperature.
○ Pre-Lysis Wash Buffer	-20°C Reagents	1	Thaw at room temperature then store on ice. Mix by pipetting 3x.
● Pre-Lysis Dilution Buffer	-20°C Reagents	1	Thaw at room temperature then store on ice until use in Section 1.8. Mix by pipetting 3x before use.

2. Place the Parse Metal Cold Block on Deck C.

3. Place the ASSIST PLUS Slanted Plate Holder set to 10° on Deck B. The lower end should be on the left. Deck layout should correspond to the configuration below.



4. Change the pipette that is connected to the INTEGRA ASSIST PLUS:
 - a. Remove the VIAFLO 12-Ch 5-125 µL pipette and corresponding tip deck. Ensure it is disconnected by pressing the back button until the main menu is displayed.
 - b. Replace it with the D-ONE Pipetting Module 1-Ch, 5-1250 µL pipette and corresponding tip deck. Ensure the tip deck and tip boxes are securely positioned by pressing them down firmly until they click into place. Remove the tip box lids prior to starting the program.

5. Load the following reagents to their respective positions on the Parse Metal Cold Block on Deck C.
 - a. Column 2:
 - i. Pos 8: ● Spin Additive.
 - b. Column 3:
 - i. Pos 1: ○ Pre-Lysis Wash Buffer.
 - ii. Pos 6: a clean 10 mL transport tube.

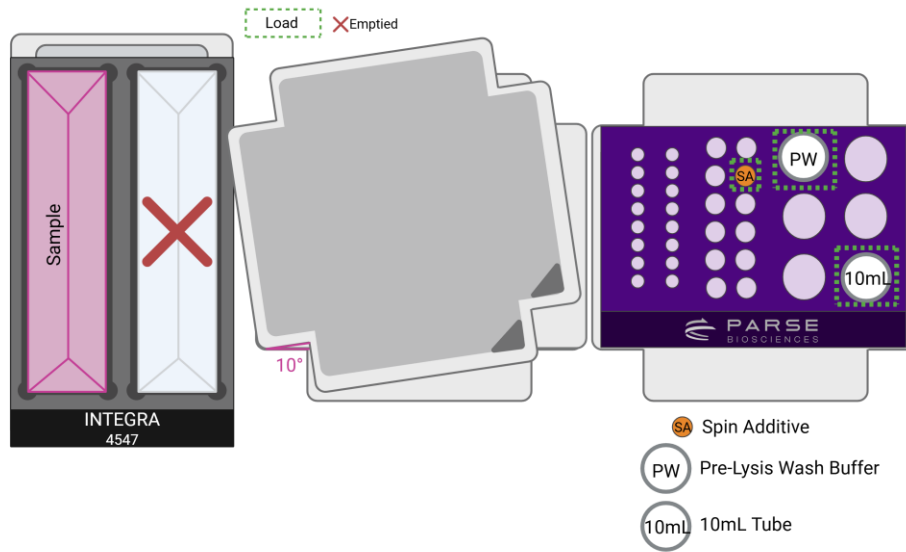

6. Remove reagent caps, select and run the program **MG S1 St7 V3_5** following the diagram below.

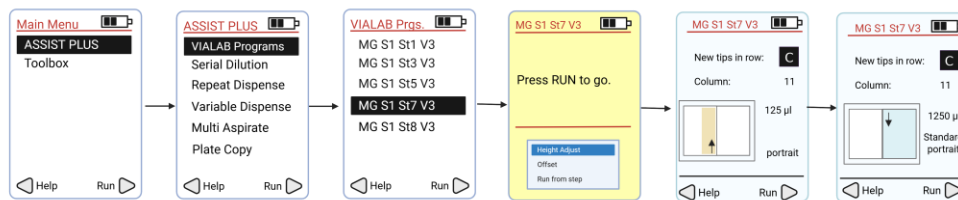

7. Press “Run” to continue the program. Follow the program prompts for manual intervention:

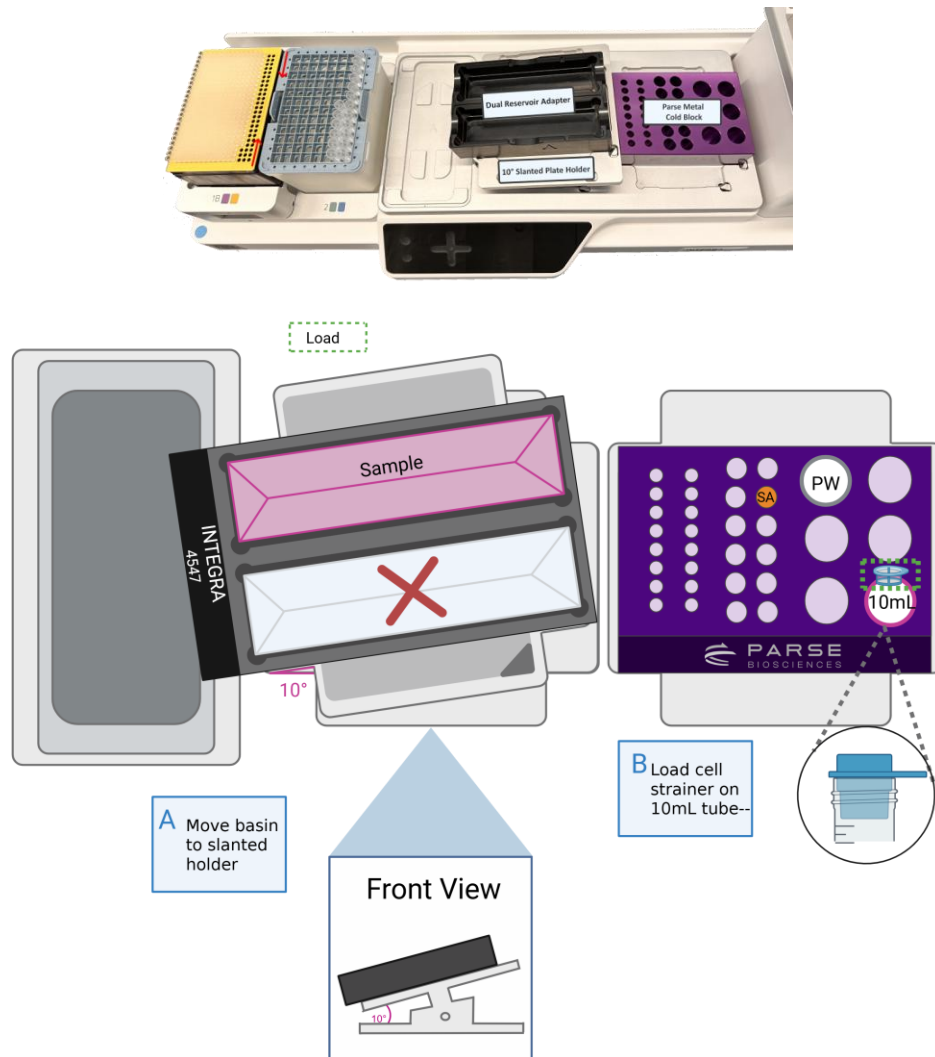

- a. Move the Dual Reservoir Adapter with the sample from Deck A to the slanted plate holder on Deck B. The INTEGRA logo at the front of the Dual Reservoir Adapter faces towards the pipette tip box. The sample should now be located on the top reservoir of the Dual Reservoir Adapter.



Note: When moving the dual reservoir adapter onto the slanted plate holder on Deck B, use extra care when moving the sample to avoid spills.

- b. Load a cell strainer so it sits inside of the 10 mL transport tube.

8. Press "Run" to continue the program. Follow the program prompts for manual intervention:

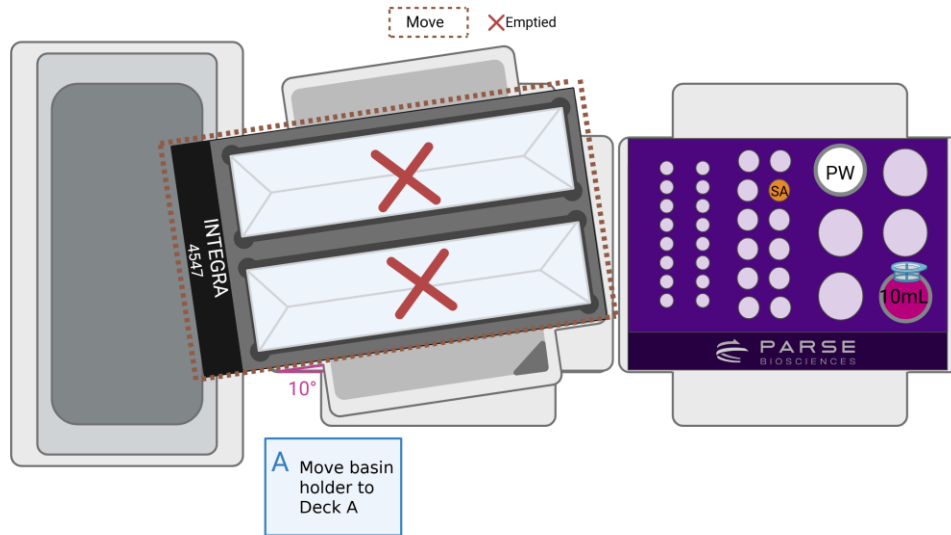

- a. Move the Dual Reservoir adapter back to Deck A. Ensure that the INTEGRA logo is facing the front.

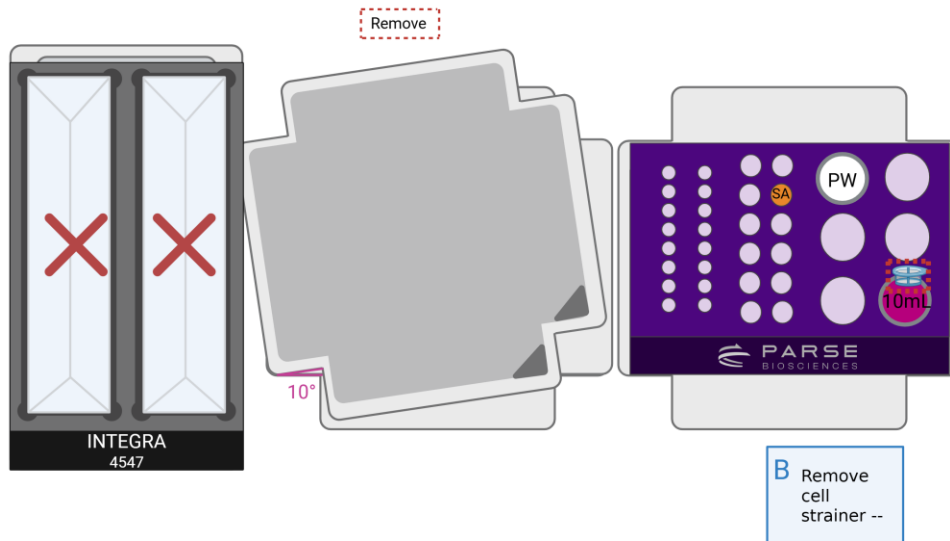

- b. Remove the used cell strainer from the 10 mL transport tube on Deck C, position 6.



Note: There may be bubbles left on the strainer. This will not affect the results.

9. Press “Run” to continue the program. Follow the program prompts for manual intervention:

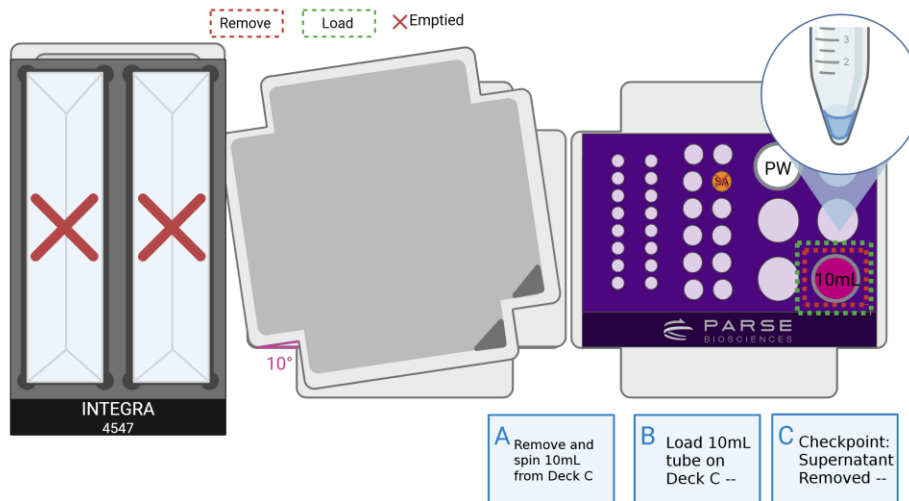

- Cap and invert once the 10 mL transport tube containing the pooled cells. Centrifuge the sample in a swinging bucket centrifuge cooled to 4°C for **10 minutes** at 250-500 x g.
- Once centrifugation is complete, remove the cap from the 10 mL transport tube and place it back in its original position within the Parse Metal Cold Block on Deck C.
- After removing the supernatant, inspect the 10 ml tube and visually confirm that the supernatant has been removed, leaving only a small volume at the bottom. A pellet may not be visible. Avoid disturbing the pellet—do not insert the pipette tip into the pellet area to measure the supernatant.



CRITICAL! Return the 10 mL transport tube to the Parse Metal Cold Block immediately after centrifugation. Handle the tube with care to avoid jostling or disturbing the pellet. If the pellet becomes resuspended prior to supernatant removal, it may lead to loss of cells.

10. Press “Run” to continue the program. Follow the program prompts for manual intervention:

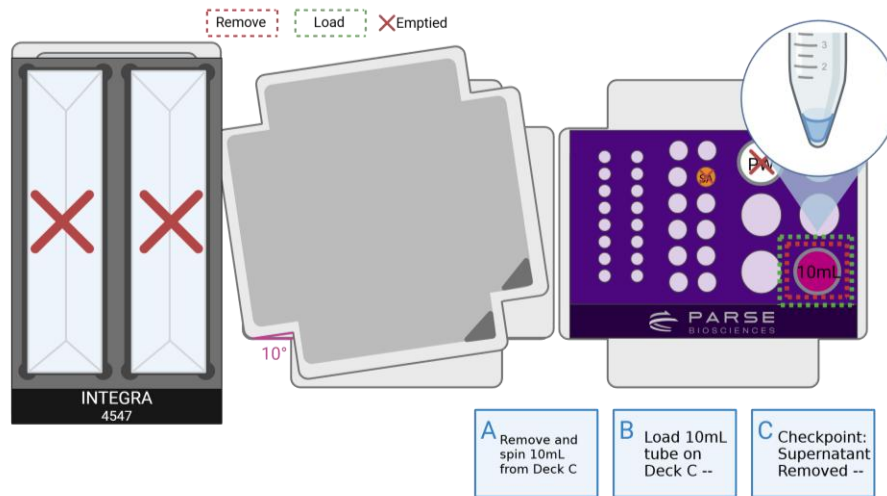

- Cap and invert once the 10 mL transport tube containing the pooled cells. Centrifuge the sample in a swinging bucket centrifuge cooled to 4°C for **10 minutes** at 250-500 x g.
- Once centrifugation is complete, remove the cap from the 10 mL transport tube and place it back in its original position within the Parse Metal Cold Block located on Deck C, position 6.
- After removing the supernatant, inspect the 10 ml tube and visually confirm that the supernatant has been removed, leaving only a small volume at the bottom. A pellet may not be visible. Avoid disturbing the pellet—do not insert the pipette tip into the pellet area to measure the supernatant.



CRITICAL! Immediately return the 10 mL transport tube to the Parse Metal Cold Block after centrifugation. Handle the tube with care to avoid jostling or disturbing the pellet. If the pellet becomes resuspended prior to supernatant removal, it may lead to loss of cells.

11. At the conclusion of the run:

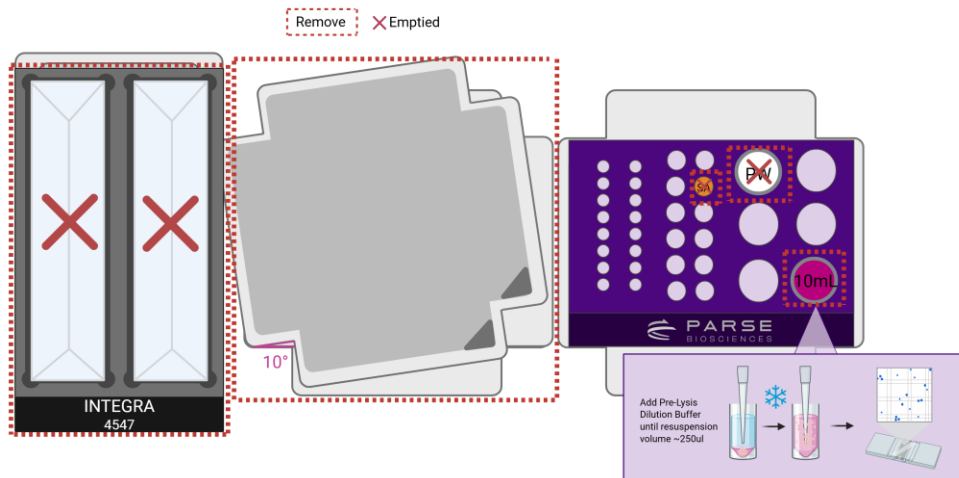

- a. Store the 10 mL transport tube on Deck C on ice. If the remaining volume in the 10 mL transport tube is less than 100 μ L, add ● Pre-Lysis Dilution Buffer for a final total volume of 250 μ L. Minimizing time on ice, mix and count the number of cells in the sample from the 10 mL transport tube on Deck C with a hemocytometer or alternative counting device. Record the cell count.



Note: Only count intact cells. Including damaged or broken cells can compromise data quality and will be excluded during downstream analysis.

- b. Discard the used 1.5 mL and 5 mL reagent tubes on Deck C.
- c. Keep the Parse Metal Cold Block on Deck C. It will be used in the next step.
- d. Remove all labware on Deck A. Discard the used reservoir liners and their contents.
- e. Remove all labware on Deck B.

1.8. Lysis and Sublibrary Generation

The program requires a dilution of the sample to 2500 cells per μL with a volume of 420 μL . The program will create sixteen lysates with 62,500 cells each. It then mixes the Lysis Master Mix and aliquots the master mix into the generated lysates.

To generate and lyse sublibraries:

1. Gather the following components and reagents:

ITEM	SOURCE	QTY	HANDLING AND STORAGE
D-ONE Pipetting Module 1-Ch, 5-1250 μL	INTEGRA Component	1	
Tip Deck for D-ONE Pipetting Module	INTEGRA Component	1	
Parse Metal Cold Block	Parse	1	Keep on ice when not in use.
8-count PCR strip tube	Consumables	2	
1.5 mL tube	Consumables	2	
125 μL Tip Rack	INTEGRA	1	
1250 μL Tip Rack	INTEGRA	1	
● Lysis Buffer	4°C Reagents	1	Place in a 37°C water bath until use.
● Lysis Enzyme	-20°C Reagents	1	Place directly on ice. Briefly centrifuge before use.

2. Dilute the cells to a concentration of 2,500 cells per μL for a total volume of at least **420 μL** using the ● Pre-Lysis Dilution Buffer in a 1.5 mL transport tube. Store this dilution on ice until ready to use.

Note: If you do not have at least 1,000,000 cells, dilute the remaining cells to 420 μL and record the amount of cells per sublibrary.

Note: The robot uses 25 μL of this sample dilution to generate the lysates. If lysates of another size is required, dilute the sample suspension to a different concentration. (Example: A sample suspension with the concentration of 300 cells/nuclei per μL will create lysates with 7,500 cells.)



Note: Automated dispensing of 1,000,000 cells across 16 sublibraries requires a minimum input of 1,050,000 cells. If fewer than 1,050,000 cells are available, the dispensing can be performed manually to ensure maximum utilization of all available cells.

3. The deck layout should correspond to the configuration below.

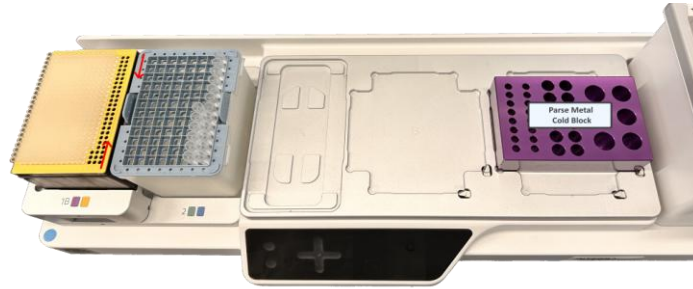

4. Load the following reagents to their respective positions on the Parse Metal Cold Block on Deck C.

- a. Column 1, left: Two 8-count PCR strip tubes.
- b. Column 2:
 - i. Pos 1: diluted sample in a 1.5 mL tube.
 - ii. Pos 6: a clean 1.5 mL tube.
 - iii. Pos 11: ● Lysis Buffer.
 - iv. Pos 12: ● Lysis Enzyme.

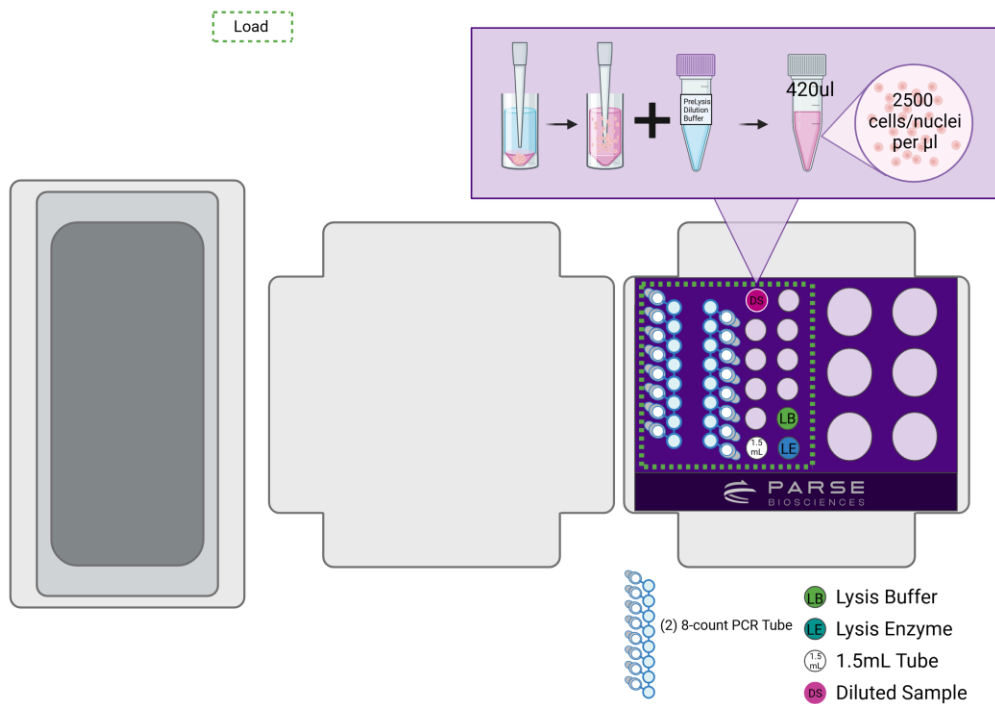

5.

Remove the reagent caps, ensure that all strip tubes are open, select and run the program **MG S1 St8 V3_5** following the diagram below.

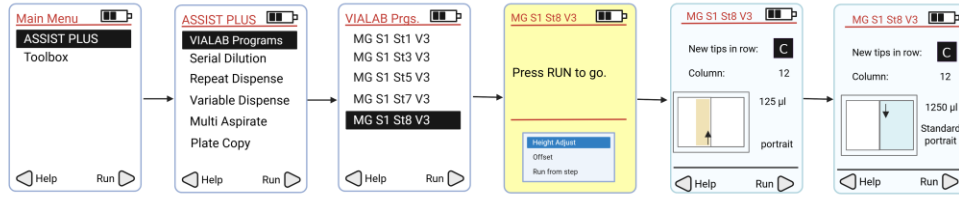

6. At the conclusion of the run:

- a. Remove the PCR strip tubes from Deck C. Securely cap and vortex the 0.2 mL tube(s) for **10 seconds**. Briefly centrifuge. Place the tube(s) into a thermocycler and run the following program.

CELL LYSIS		
Run Time	Lid Temperature	Sample Volume
15 min	80°C	55 µL
Step	Time	Temperature
1	15 min	65°C
2	Hold	4°C

- b. Freeze the lysate(s) at -80°C or proceed to Section 2 while the program is still running.



Safe stopping point: Sublibrary lysates can be stored at -80°C for up to 6 months.

Section 2: cDNA Capture and Amplification

2.1. Reagents Plating

SPRI beads, Streptavidin Beads, and Binding Buffer are dispensed into 8-count PCR strip tubes. The Bead Wash, Wash 1, Wash 2, and Wash 3 Buffers are dispensed into the INTEGRA 8 Row Reservoir on Deck A. Capture enhancer is then added to the lysates created in Section 1.

1. Fill an ice bucket.
2. Gather the following items and handle as indicated below.

ITEM	SOURCE	QTY	HANDLING AND STORAGE
D-ONE Pipetting Module 1-Ch, 5-1250 µL	INTEGRA Component	1	
Tip Deck for D-ONE Pipetting Module	INTEGRA Component	1	
24 mm Labware Pedestal	INTEGRA Component	1	
Parse Metal Cold Block	Parse	1	Keep on ice when not in use.
HEATMAG with 96 Well Adapter	INTEGRA Component	1	
8 Row Reservoir	INTEGRA	1	Individually wrapped consumable
300 mL Reservoir Base	INTEGRA	1	
8-count PCR strip tubes	Consumables	3	
125 µL Tip Rack	INTEGRA	1	
1250 µL Tip Rack	INTEGRA	1	
● Streptavidin Beads	4°C Reagents	1	Keep at room temperature.
● Binding Buffer	-20°C Reagents	1	Thaw at room temperature then store on ice. Mix by inverting 3x.
● Enhancer	-20°C Reagents	1	Place directly on ice. Briefly centrifuge before use.
○ Bead Wash Buffer	-20°C Reagents	1	
○ Wash Buffer 1	-20°C Reagents	1	

ITEM	SOURCE	QTY	HANDLING AND STORAGE
○ Wash Buffer 2	-20°C Reagents	1	Thaw at room temperature then store on ice. Mix by inverting 3x.
○ Wash Buffer 3	-20°C Reagents	1	
SPRI Beads	Consumables and Reagents		Equilibrate at room temperature before use.

- Place the 24 mm Labware Pedestal on Deck A.
- Place the Parse Metal Cold Block on Deck B.
- Place the HEATMAG with 96 Well PCR Adapter (INTEGRA logo oriented to the front) on Deck C. Ensure HEATMAG power is on for the entire duration of Section 2.

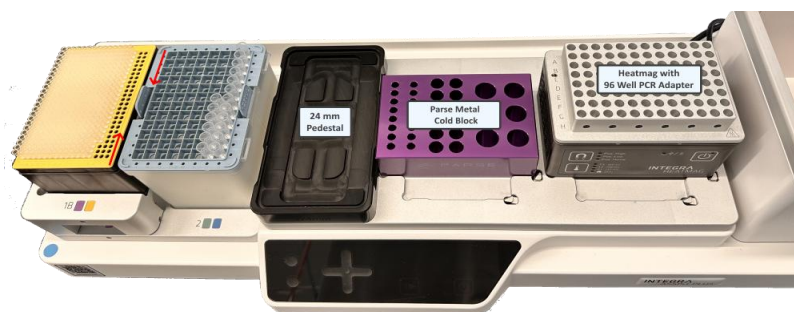

- Attach D-ONE Pipetting Module 1-Ch, 5-1250 μL and the corresponding tip rack.
- On the 24 mm Pedestal, place a clean INTEGRA 8 Row Reservoir with the 300 mL Reservoir Base.
- Vortex, and dispense **1,420 μL** SPRI beads into a 2 mL tube.
- Vortex ● Streptavidin Beads.



Note: Ensure that the ● Streptavidin Beads and SPRI Beads are thoroughly mixed before placing them on the deck. Beads can settle if the program isn't started immediately after loading all reagents.

10. Briefly centrifuge and load the following reagents and consumables to their respective positions on the Decks A, B and C:
- Deck A: clean 8 Row Reservoir.
 - Deck B, column 1, left: a clean 8-count PCR strip tube.
 - Deck B, column 2:
 - Pos 5: Fully resuspended SPRI beads
 - Pos 6: ● Binding Buffer.
 - Pos 11: ● Enhancer.
 - Pos 12: Fully resuspended ● Streptavidin Beads.
 - Deck B, column 3:
 - Pos 1: ○ Bead Wash Buffer.
 - Pos 2: ○ Wash Buffer 1.
 - Pos 3: ○ Wash Buffer 2.
 - Deck C: Two clean 8-count PCR strip tubes with the caps facing to the left in columns 5 and 7 on the HEATMAG.

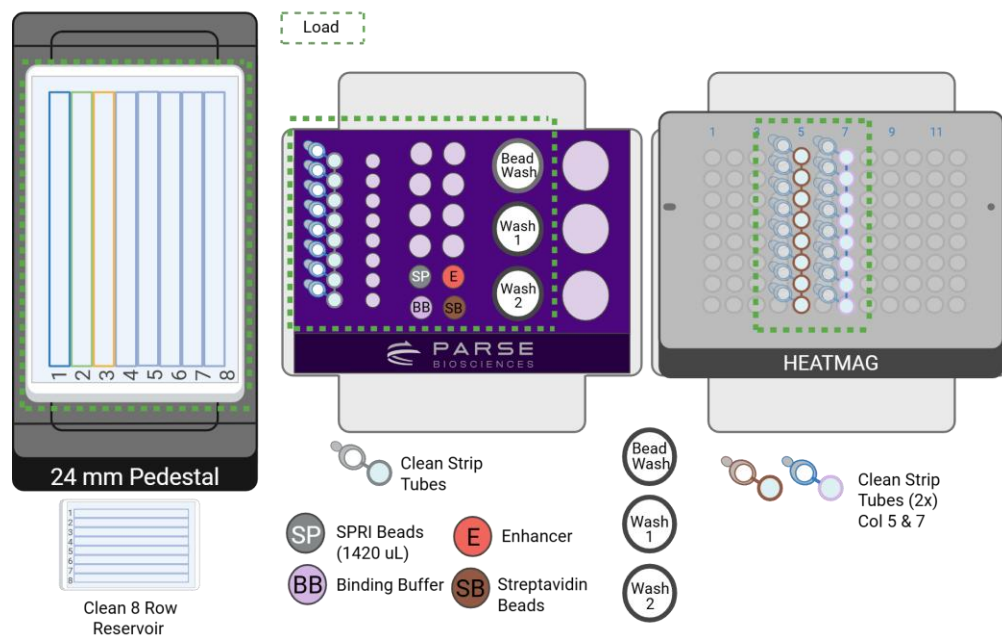

11. Remove the reagent caps and ensure that all strip tubes are open.

12. On the D-ONE Pipette select and run the program **MG S2 St1 V3_5** following the diagram below.

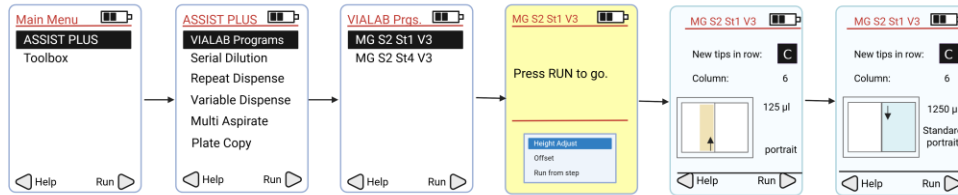

13. If continuing directly from Section 1, store lysates on ice until prompted.

14. If lysates are previously frozen, when prompted, incubate the lysates in a thermocycler at 37°C for **5 minutes** to thaw them. Press "Run" on the pipette to continue the program while the lysates are thawing.



Note: The program will remind you to thaw the lysate. Press "Run" to continue the program if continuing directly from Section 1.

Note: When thawing the lysate, ensure there is no precipitate before proceeding. Otherwise, an additional 5 minutes at 37°C should be sufficient.

15. When lysates finish thawing, briefly centrifuge and store at room temperature.

16. Press "Run" to continue the program. Follow the program prompts for manual intervention:

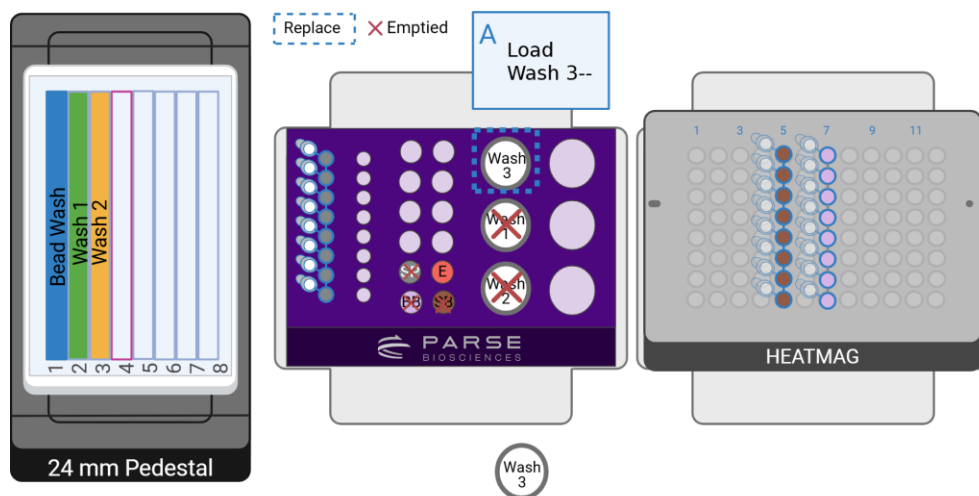

- a. Replace the  Bead Wash Buffer with  Wash Buffer 3 on Deck B, column 3, position 1.

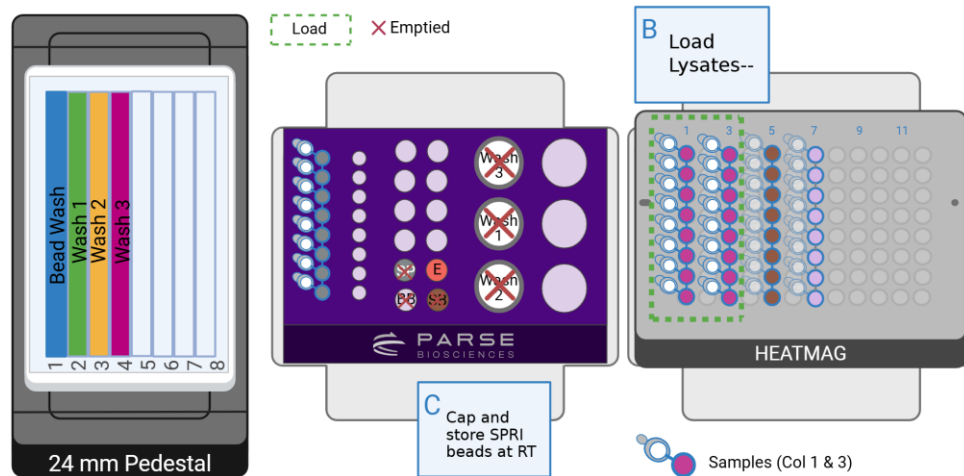

- b. Load the thawed lysates in columns 1 and 3 of the HEATMAG with 96 Well PCR Adapter. Press "Run" to continue.



Note: Ensure the 8-count PCR strip tube caps are facing the same direction. Push the PCR strip tube caps wide open to avoid interference with the pipette's tips.

- c. When prompted, cap and store the PCR strip tubes on column 1 left position of the Parse Metal Cold Block on Deck B at room temperature until after cDNA cleanup. Label these tubes as SPRI beads.

18. At the conclusion of the run:

- a. Verify that Streptavidin Bead volumes in column 5 of Deck C are even.
- b. Verify that the Binding Buffer volumes in column 7 of Deck C are even.
- c. Verify that all wash buffers have been transferred to the 8 Row Reservoir.



Note: Refer to Appendix B for specific volumes.

- d. Remove and discard empty tubes on Deck B. Place the SPRI bead tubes aside for later use.
- e. Proceed immediately to Section 2.2.

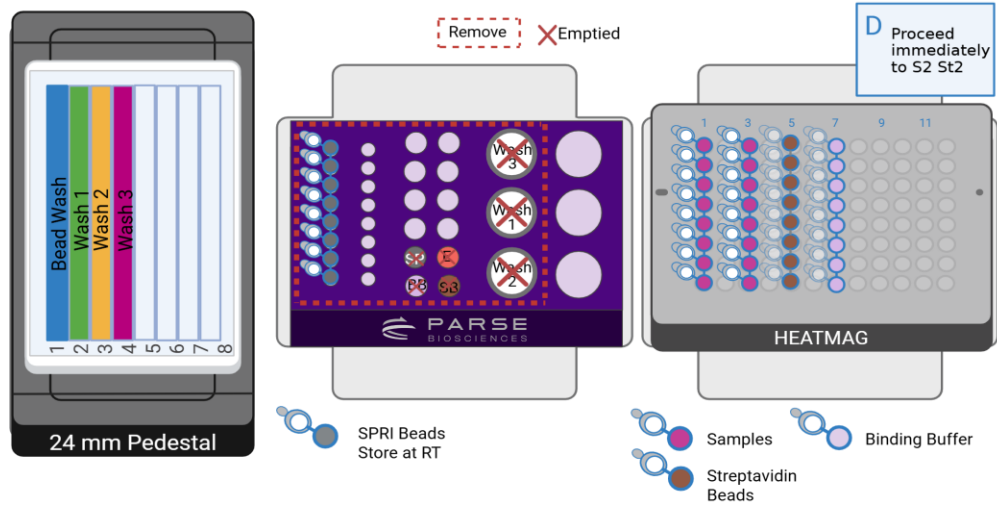

2.2. cDNA Capture

Streptavidin Beads are washed, then cDNA is captured with streptavidin-coated magnetic beads. The program controls the temperature and strength of the HEATMAG with 96 Well Adapter on Deck C.

To capture the cDNA:

1. Gather the following items and set up the deck as shown.

ITEM	SOURCE	QTY	HANDLING AND STORAGE
VOYAGER Pipetting Module 8-Ch 5-125 μ L	INTEGRA Component	1	
Tip Deck for VOYAGER Pipetting Module	INTEGRA Component	1	
125 μ L Tip Rack	INTEGRA	1	

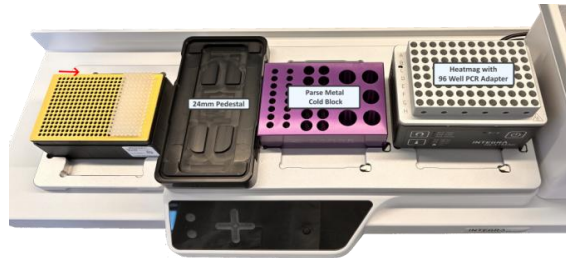

2. Load the following uncapped strip tubes (if removed from previous steps) to their respective positions on the HEATMAG with 96 Well PCR Adapter:
 - a. Samples on columns 1 and 3.
 - b. Streptavidin Beads on column 5.
 - c. Binding Buffer on column 7.

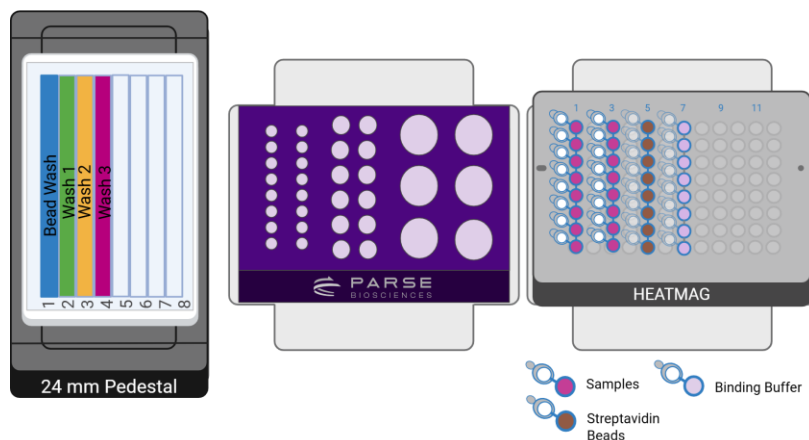

3. Change the pipette that is connected to the INTEGRA ASSIST PLUS:
 - b. Remove D-ONE Pipetting Module 1-Ch, 5-1250 μ L and corresponding Tip Deck. Ensure it is disconnected by pressing the back button until the main menu is displayed.
 - c. Replace it with VOYAGER 8-Ch 5-125 μ L Pipette and corresponding Tip Deck. Ensure the Tip Deck and Tip Box are securely positioned by pressing them down firmly until they click into place. Remove the tip box lid prior to starting the program.
4. Select and run the program **MG S2 St2 V3_5** following the diagram below.

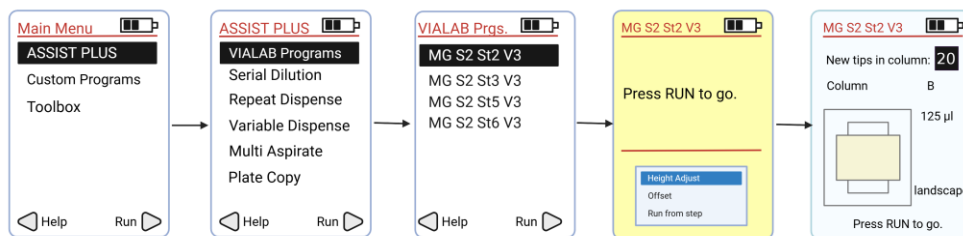

5. Press "Run" to continue the program. Follow the program prompts for manual intervention:
 - a. Cover the 8 Row Reservoir to avoid contamination.
 - b. Cap the sample strip tubes on Deck C columns 1 and 3.
 - c. Place the strip tubes into a 96 well PCR tube rack, press to secure, and ensure the caps are secured tightly.
 - d. Place the rack onto a vortex mixer with a plate adapter. Push to secure. Vortex on 100% power for **1 minute**.
 - e. Vortex on 20% power (~800-1000 RPM) for **30 minutes** at room temperature.



Note: To ensure the beads are being mixed sufficiently, check that the beads are in solution **10 minutes** into the incubation. If settled, increase the vortex mixing speed to keep the beads in solution.

- f. While the samples are vortexing, press "Run" to complete the program.
- g. Discard the used strip tubes in columns 5 and 7 on Deck C and proceed to Section 2.3.

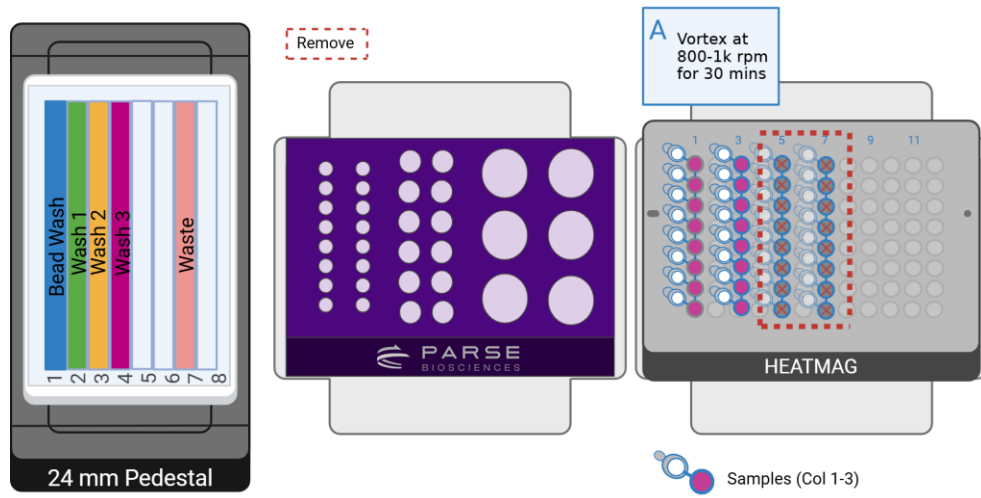

2.3. Streptavidin Beads Wash

Captured cDNA samples are washed to remove cellular debris.

1. Briefly centrifuge the captured cDNA sample tubes for **30 seconds** at 100 x g at 4°C.
2. Uncap and place the sample tubes back on the HEATMAG with 96 Well Adapter on Deck C, columns 1 and 3.



Note: Ensure the PCR strip tube caps are facing the same direction. Push the PCR strip tube caps wide open to avoid interference with the pipette's tips.

3. Uncover the 8 Row Reservoir. The deck layout should correspond to the configuration below.

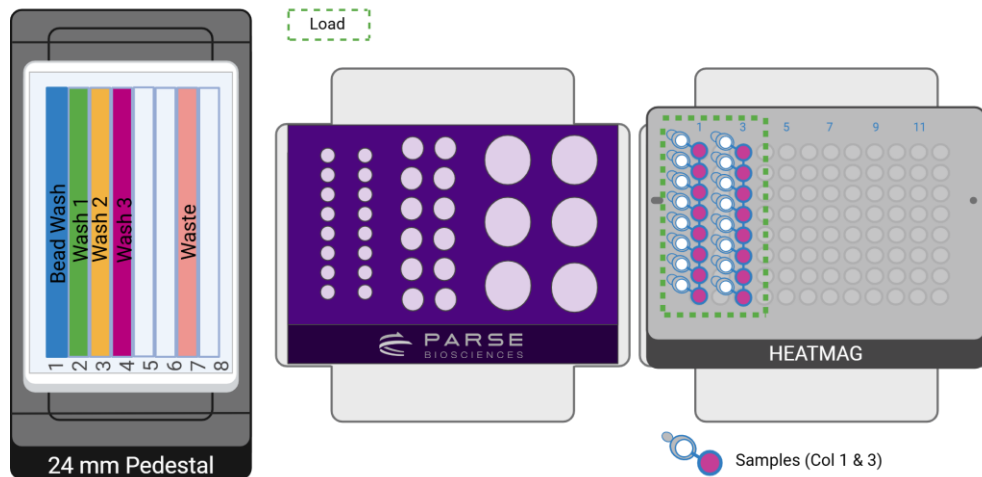

4. Select and run the program **MG S2 St3 V3_5** following the diagram below.

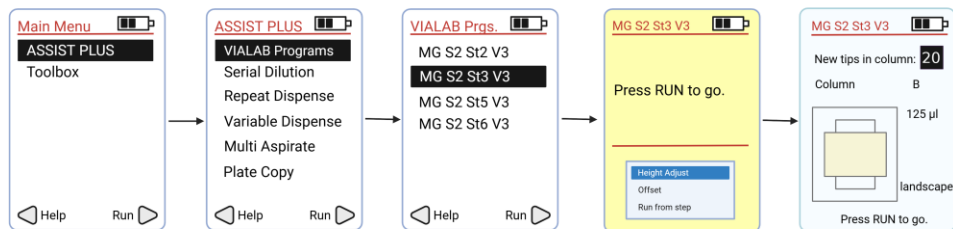

5. At the conclusion of the run, proceed immediately to section 2.4.

2.4. Master Mixes Preparation

The program prepares the Template Switch Master Mix and the cDNA Amplification Master Mix for the template switch and the cDNA amplification reactions.

To prepare reagents:

1. Gather the following items and handle as indicated below:

ITEM	SOURCE	QTY	HANDLING AND STORAGE
D-ONE Pipetting Module 1-Ch, 5-1250 µL	INTEGRA Component	1	
Tip Deck for D-ONE Pipetting Module	INTEGRA Component	1	
Parse Metal Cold Block	Parse	1	
24 mm Labware Pedestal	INTEGRA Component	1	
HEATMAG with 96 Well Adapter	INTEGRA Component	1	
300 mL Reservoir Base	INTEGRA Component	1	
8-count PCR strip tubes	Consumables	2	
2 mL tubes	Consumables	2	
125 µL Tip Rack	INTEGRA	1	
1250 µL Tip Rack	INTEGRA	1	
● Template Switch Buffer	-20°C Reagents	1	Thaw at room temperature then place on ice. Mix by inverting 3x. Briefly centrifuge before use.
● Template Switch Primer	-20°C Reagents	1	
● Template Switch Enzyme	-20°C Reagents	1	Keep on ice. Briefly centrifuge before use.
● cDNA Amp Mix	-20°C Reagents	1	Thaw at room temperature then place on ice. Mix by inverting 3x. Briefly centrifuge before use.
● cDNA Amp Primers	-20°C Reagents	1	



Note: Ensure that there is no precipitate in the ● Template Switch Buffer before proceeding.

2. Set up the deck following the Deck Configuration below.



3. On Deck B, on the Parse Metal Cold Block, place the following consumables and reagents using the deck configuration below:

- a. Column 1, left and right: two clean 8-count PCR strip tubes.
- b. Column 2:
 - i. Pos 1: ● Template Switch Buffer.
 - ii. Pos 2: ● Template Switch Enzyme.
 - iii. Pos 3: ● Template Switch Primer.
 - iv. Pos 4: a clean 2 mL tube.
 - v. Pos 7: ● cDNA Amp Mix.
 - vi. Pos 8: ● cDNA Amp Primers
 - vii. Pos 9: a clean 2 mL tube.

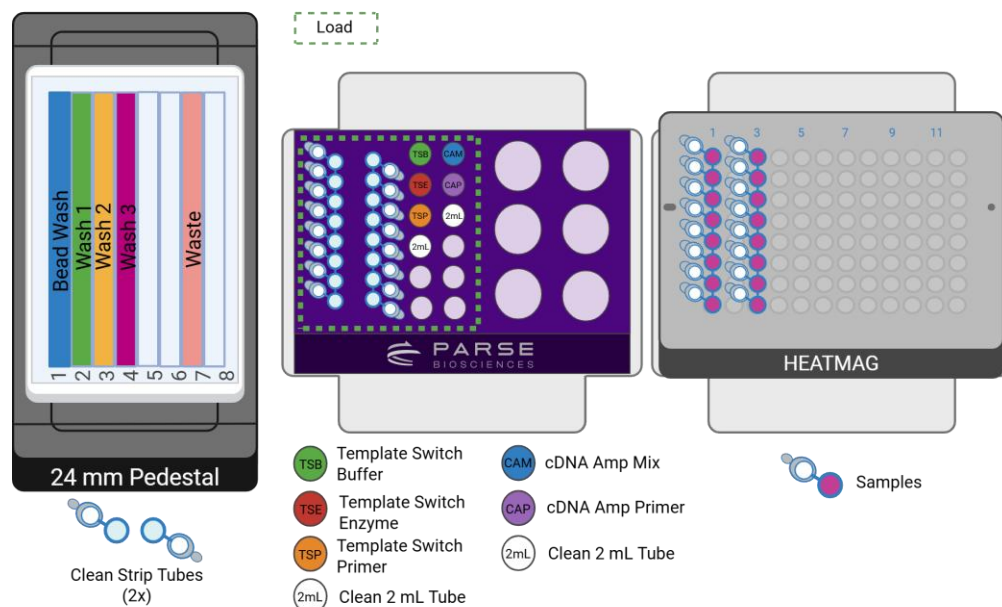

4. Change the pipette that is connected to the INTEGRA ASSIST PLUS:

- a. Remove the VOYAGER 8-Ch 5-125 μ L Pipette and corresponding Tip Deck. Ensure it is disconnected by pressing the back button until the main menu is displayed.
 - b. Replace it with D-ONE Pipetting Module 1-Ch, 5-1250 μ L and corresponding Tip Deck. Ensure the tip deck and tip boxes are securely positioned by pressing them down firmly until they click into place. Remove the tip box lids prior to starting the program.
5. Remove the reagent caps, select and run the program **MG S2 St4 V3_5** following the diagram below.

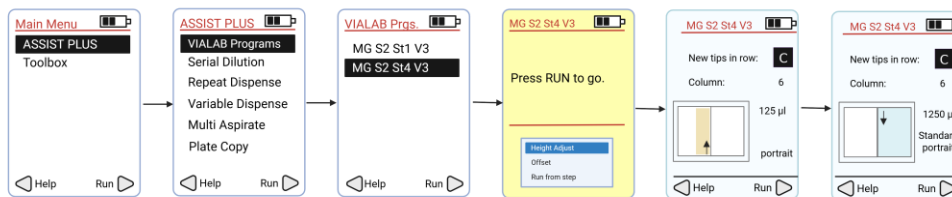

6. Press "Run" to continue the program. Follow the program prompts for manual intervention:
 - a. Cap, label, and store the cDNA Amplification Master Mix dispensed in the right PCR strip tube on Deck B, column 1, right side on ice. Verify the volume is even. Press "Run" to continue.

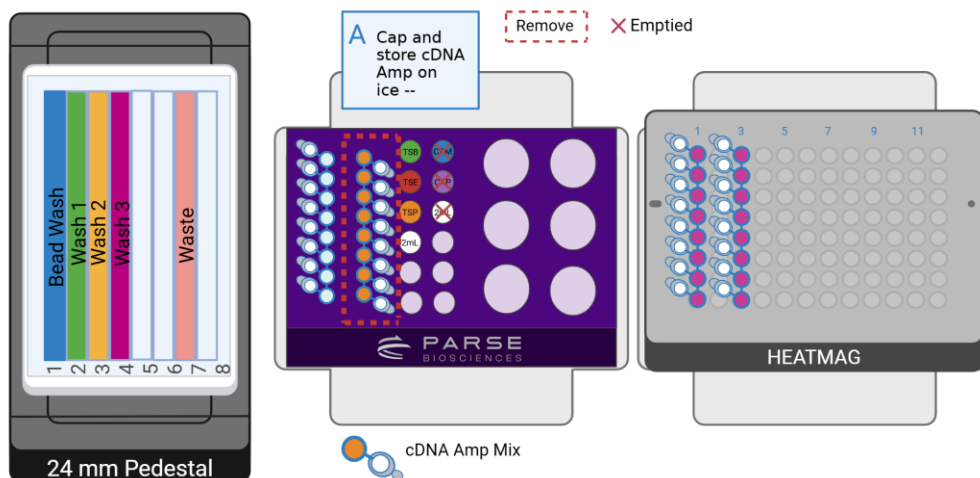

7. At the conclusion of the run:

- a. Verify that the volume of the Template Switch Master Mix in the left PCR strip tube on Deck B, column 1 left is even (~210 μ L). Keep it on this position as it will be used in the next step.

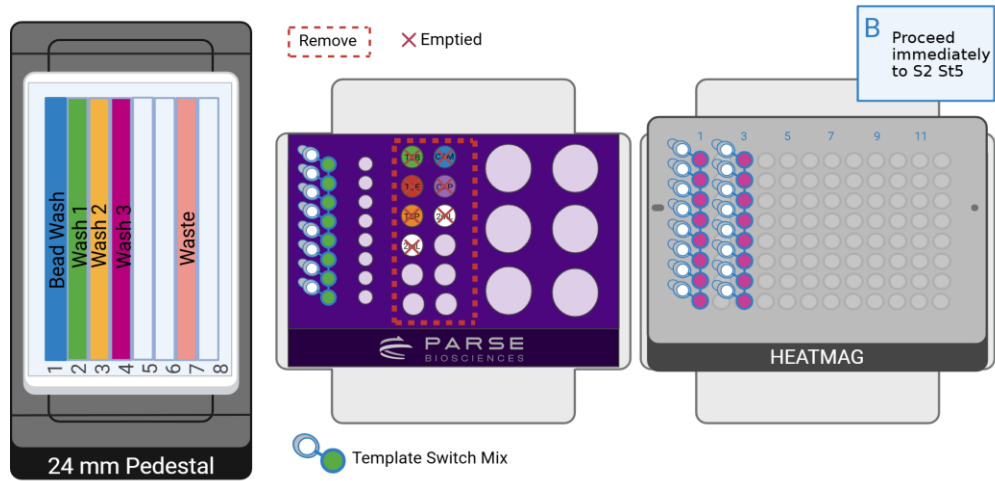

- b. Remove and discard used 1.5 mL and 2 mL reagent tubes on Deck B, column 2.

2.5. Template Switch and cDNA Amplification

The Template Switch Master Mix is added to the captured cDNA and incubated for 30 minutes. The template switch reaction adds a 5' adapter to the cDNA.

To perform template switch:

1. Gather the following items and set up the deck indicated:

ITEM	SOURCE	QTY	HANDLING AND STORAGE
VOYAGER 8-Ch 5-125 μ L	INTEGRA Component	1	
Tip Deck for VOYAGER Pipetting Module	INTEGRA Component	1	
Parse Metal Cold Block	Parse	1	
24 mm Labware Pedestal	INTEGRA Component	1	
HEATMAG with 96 Well Adapter	INTEGRA Component	1	
300 mL Reservoir Base	INTEGRA Component	1	
125 μ L Tip Rack	INTEGRA	1	

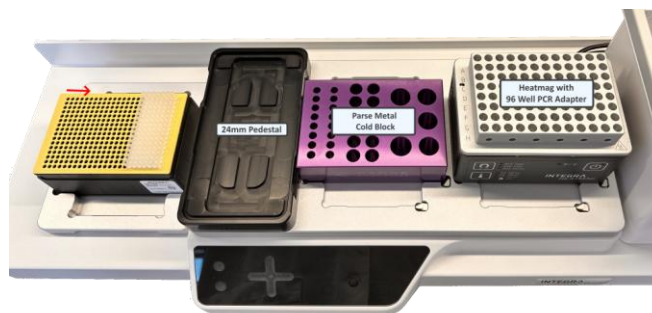

2. Ensure the following are loaded following the deck configuration below:
 - a. Deck B, column 1, left: 8-count PCR strip tube with Template Switch Master Mix.
 - b. Deck C, columns 1 and 3: Samples on the HEATMAG with 96 Well PCR Adapter.



Note: Ensure the PCR strip tube caps are facing the same direction. Push the PCR strip tube caps wide open to avoid interference with the pipette's tips.

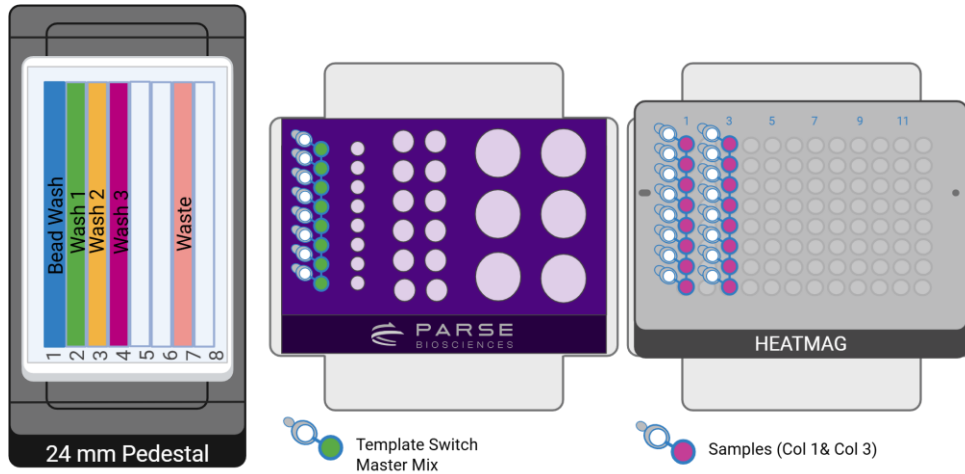

3. Change the pipette that is connected to the INTEGRA ASSIST PLUS:
 - a. Remove D-ONE Pipetting Module 1-Ch, 5-1250 μ L and corresponding Tip Deck. Ensure it is disconnected by pressing the back button until the main menu is displayed.
 - b. Replace it with VOYAGER 8-Ch 5-125 μ L Pipette and corresponding Tip Deck. Ensure the Tip Deck and Tip Box are securely positioned by pressing them down firmly until they click into place. Remove the tip box lid prior to starting the program.
4. On the VOYAGER Pipette select and run the program **MG S2 St5 V3_5** following the diagram below.

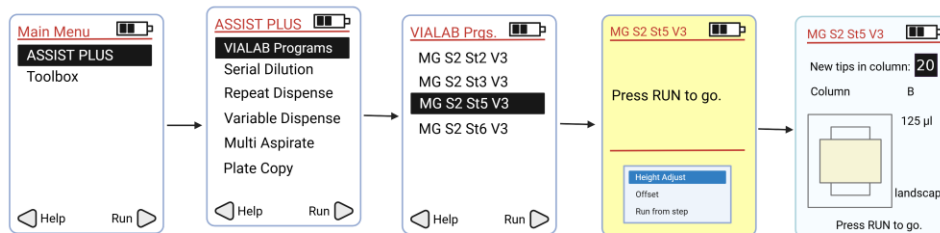

- Press "Run" to continue the program. Follow the program prompts for manual intervention:

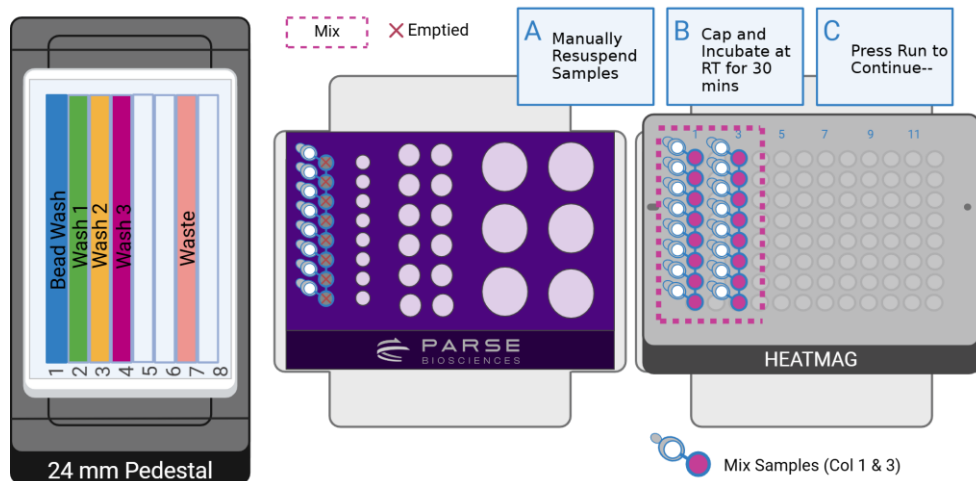

- Remove the samples from the deck and manually mix to fully resuspend the streptavidin pellet in the Template Switch Master Mix. Avoid introducing bubbles.



Note: The Template Switch Master Mix is viscous, which can make resuspending the beads challenging. Do not directly touch the bead pellet with the pipette tip, as the beads may stick to it.

- Cap the sample strip tubes on Deck C column 1. Incubate the cDNA samples on Deck C, columns 1 and 3 at room temperature for **30 minutes**. Add a PCR plate seal to the reagent reservoir on Deck A during the 30 minute incubation.
- After the 30 minute incubation, uncap the sample strip tube caps and remove the plate seal from the reservoir. Press "Run" to continue the program.



Note: Ensure the PCR strip tube caps are facing the same direction. Push the PCR strip tube caps wide open to avoid interference with the pipette's tips.

6. When prompted, remove the samples from the Deck C, columns 1 and 3 and place them into a thermocycler. Run the following program.

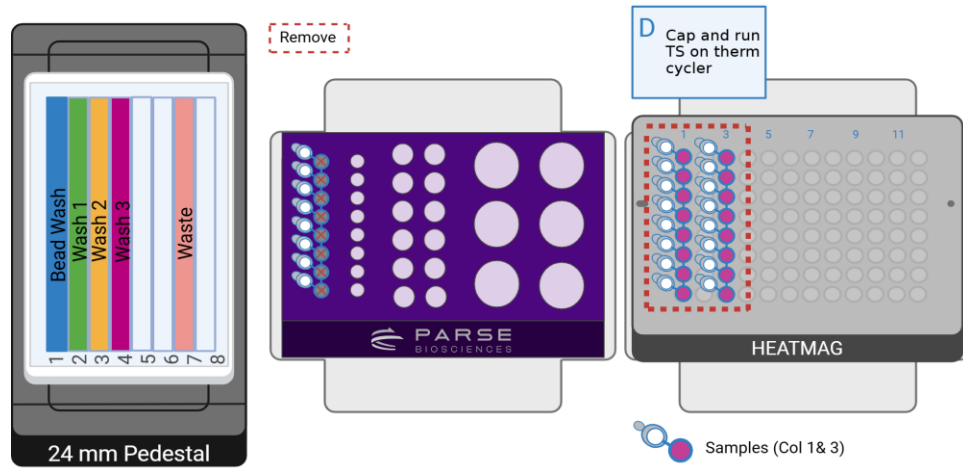

TEMPLATE SWITCH		
Run Time	Lid Temperature	Sample Volume
60 min	70°C	100 µL
Step	Time	Temperature
1	60 min	42°C
2	Hold	4°C

- Press "Run" to continue the program. Follow the program prompts for manual intervention:

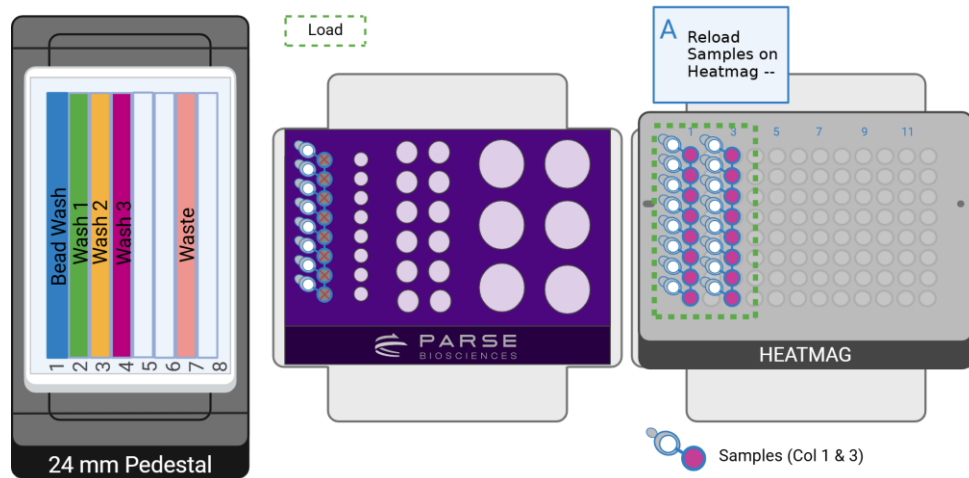

- When the Template Switch thermocycling program has completed, remove the cover from the 8 Row reservoir on Deck A and reload the samples on the HEATMAG on Deck C columns 1 and 3.



Note: Ensure the PCR strip tube caps are facing the same direction to the left. Push the PCR strip tube caps wide open to avoid interference with the pipette's tips.

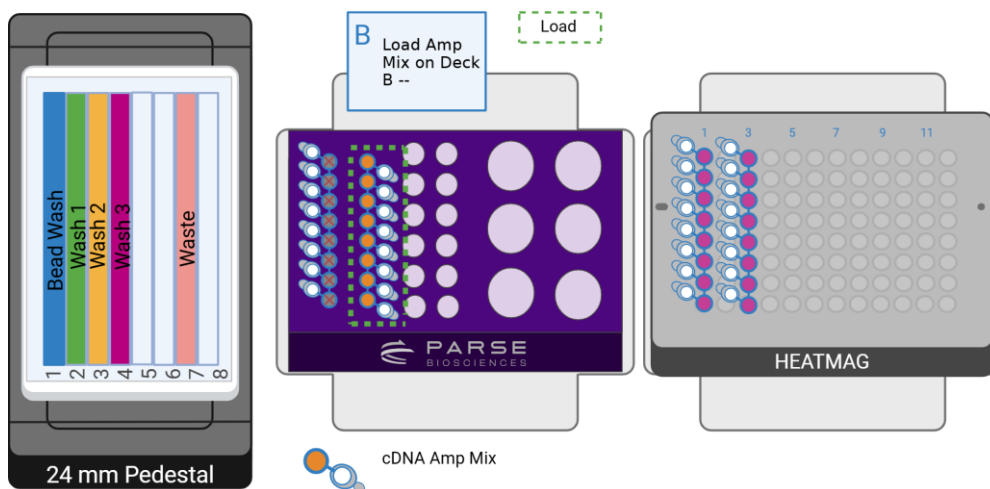

- Place the cDNA Amplification Master Mix from section 2.4.6 back into Deck B, column 1, right. Press "Run" to continue the program.

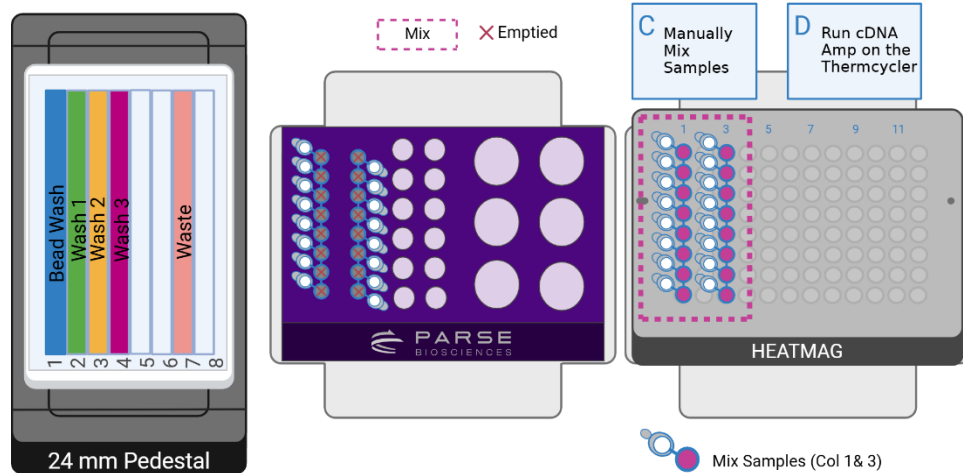

- c. Remove the samples from the deck and manually mix to fully resuspend the streptavidin pellet in the cDNA Amp Mix. Avoid introducing bubbles.
 - d. Use the guidelines below to amplify the cDNA samples.
8. Determine the number of PCR cycles required for cDNA amplification based on the table below. Although these recommendations are appropriate for many cell types, the number of cycles may need to be optimized for each sample type.

NUMBER OF PCR CYCLES				
Cells in Sublibrary	Cell lines	Human Primary B Cells	Human PBMCs	Mouse Primary B Cells
200-999	11	12	13	14
1,000-1,999	9	10	11	12
2,000-5,999	7	8	9	10
6,000-12,499	6	7	8	9
12,500-24,999	4	5	6	7
25,000-62,500	3	4	5	6

9. When prompted, place the sample strip tube into thermocycler and run the following program.

cDNA AMPLIFICATION			
Run Time	Lid Temperature	Sample Volume	
50-70 min	105°C	100 µL	
Step	Time	Temperature	Cycles
1	3 min	95°C	1
2	20 sec	98°C	5
3*	45 sec	65°C*	
4	3 min	72°C	
5	20 sec	98°C	Variable, see above
6*	20 sec	67°C*	
7	3 min	72°C	
8	5 min	72°C	1
9	Hold	4°C	1



CRITICAL! If processing sublibraries with different numbers of cells, they should be amplified in separate thermocyclers according to the recommendations above.



Note: Annealing steps 3* and 6* have different time and temperature settings. Ensure these are correct before starting the program.

10. While the thermocycler program is running:

- a. Remove and discard used strip tubes on Deck B.
- b. We recommend covering the 8 Row Reservoir with a PCR plate seal during this time to reduce contamination.

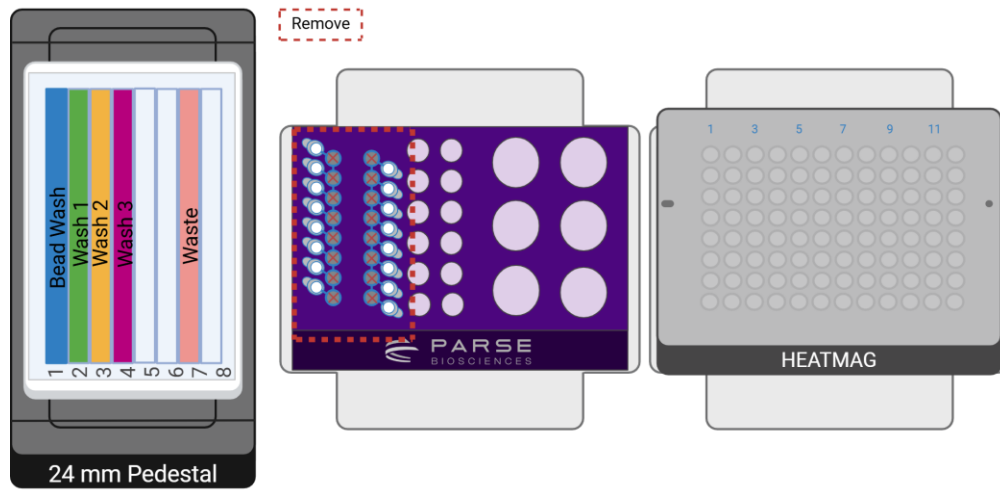

 Safe stopping point: Amplified cDNA can be stored at 4°C for up to 18 hours.

2.6. Post-Amplification Purification

Amplified cDNA is purified with a 0.8x SPRI bead cleanup.

To purify the cDNA:

1. Gather the following items and set up the deck as indicated:

ITEM	SOURCE	QTY	HANDLING AND STORAGE
VOYAGER 8-Ch 5-125 μ L	INTEGRA Component	1	
Tip Deck for VOYAGER Pipetting Module	INTEGRA Component	1	
Parse Metal Cold Block	Parse	1	
24 mm Labware Pedestal	INTEGRA Component	1	
HEATMAG with 96 Well Adapter	INTEGRA Component	1	
300 mL Reservoir Base	INTEGRA Component	1	
125 μ L Tip Rack	INTEGRA	1	
8-count PCR strip tubes	Consumables	4	
Ethanol	Consumables and Reagents		
Nuclease free water	Consumables and Reagents		
SPRI Beads	Consumables and Reagents		

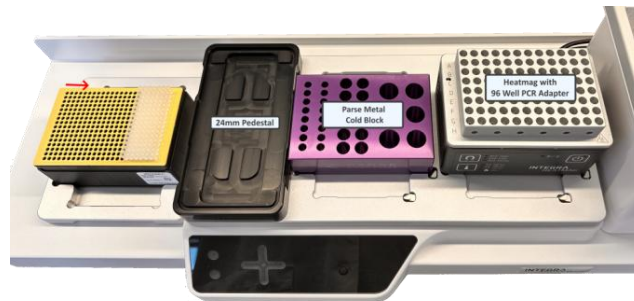

2. Prepare at least **8 mL** 85% ethanol with nuclease-free water.

3. With a P1000 pipette set at 1,000 μ L, add:
 - a. **8 mL** 85% Ethanol in lane **5** of the 8 Row Reservoir on Deck A.
 - b. **3.5 mL** nuclease free water in lane **6** of the 8 Row Reservoir on Deck A.
4. Place the dispensed SPRI beads in strip tubes from Section 2.1.17c on Deck B, column 1 (left) on the Parse Metal Cold Block. If the beads have settled, they should be manually resuspended prior to loading them on the Parse Metal Cold Block.



Note: Ensure the SPRI beads have been equilibrated to room temperature for at least 30 minutes.

5. Once the cDNA Amplification thermocycler program is complete, place the sample strip tubes in columns 1 and 3 on the HEATMAG with 96 Well Adapter on Deck C.



Note: Ensure the PCR strip tube caps are facing the same direction. Push the caps wide open to avoid interference with the pipette's tips.

6. Place 4 new 8-count PCR strip tubes in columns 5, 7, 9, and 11 on Deck C. The deck layout should correspond to the Deck Configuration below.

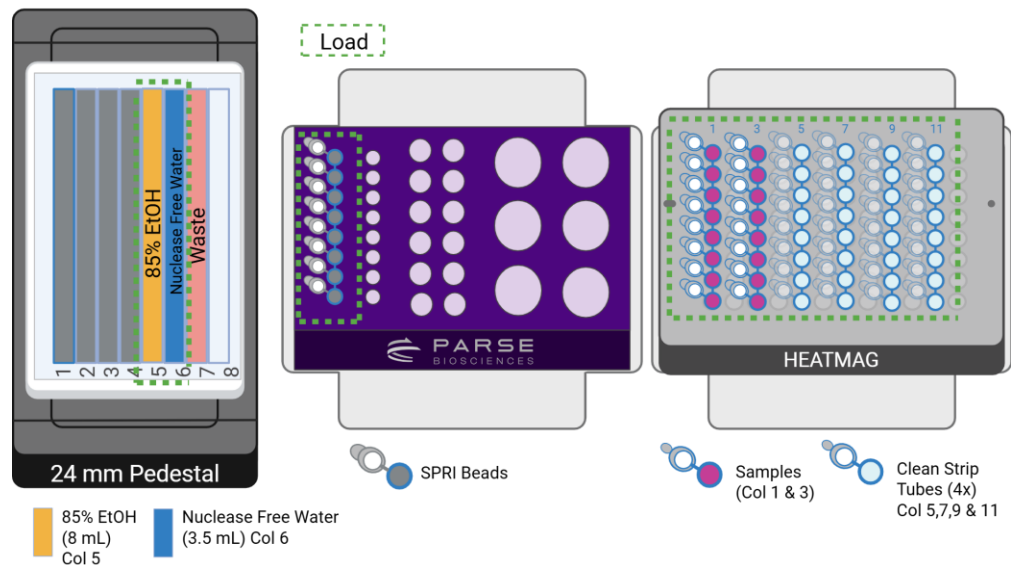

7. Select and run program **MG S2 St6 V3_5** following the diagram below.

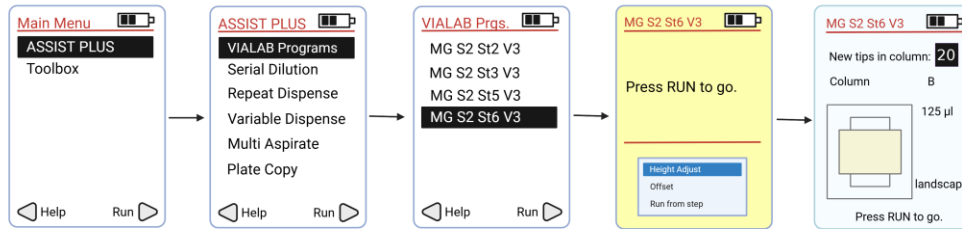

8. Press "Run" to continue the program. Follow the program prompts for manual intervention:

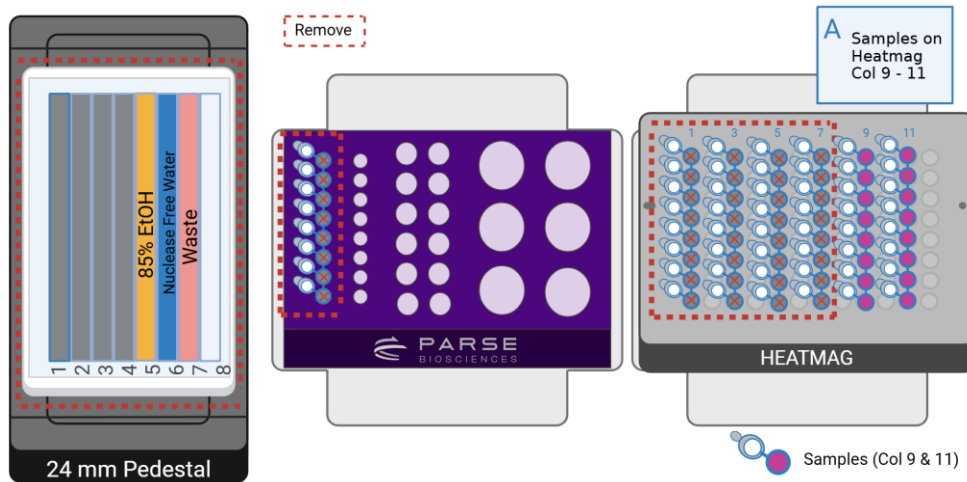

a. Final cDNA libraries are on the HEATMAG with 96 Well Adapter in columns 9 and 11. Remove and discard the empty strip tubes and the 8 row reservoir.

STOP Safe stopping point: Purified cDNA can be stored at 4°C for up to 48 hours or at -20°C for up to 3 months. Otherwise, proceed to Section 2.7 to quantify the cDNA before proceeding to Section 3 of the manual workflow in the [BCR User Manual](#).

2.7. cDNA Quantification

The concentration and size distribution of the cDNA are measured with fluorescent dyes and capillary electrophoresis. The cDNA is then stored at 4°C for up to 48 hours or at -20°C for up to 3 months.

To quantify the cDNA:

1. Measure the concentration of each tube of purified cDNA from Section 2.6 with the Qubit dsDNA HS (High Sensitivity) Assay Kit according to the manufacturer's instructions. Record the concentration(s), which will be used in Section 3.
2. Assess the size distribution of each tube of purified cDNA with a High Sensitivity DNA Kit on the Agilent Bioanalyzer System or High Sensitivity D5000 ScreenTape and Reagents on the Agilent TapeStation System according to the manufacturer's instructions.

 Safe stopping point: purified cDNA can be stored at 4°C for up to 48 hours or at -20°C for up to 3 months. Otherwise, proceed to Section 3 of the manual workflow in the [BCR User Manual](#).

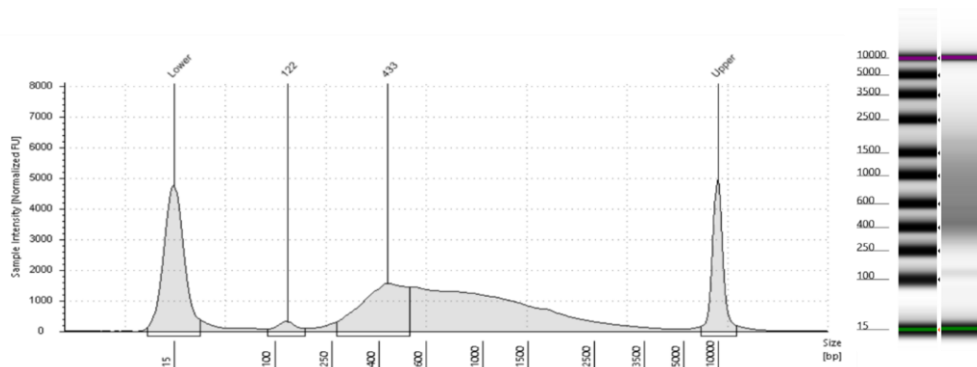

Figure 7: Expected post-amplification sublibrary cDNA size distribution. Example trace of Human cDNA run on a TapeStation.

Note: Samples may need to be diluted to be within the manufacturer's recommended concentration range. Typically, between a 1:3 to 1:10 dilution or 3-5 ng are appropriate.



Note: The traces above are representative of typical TapeStation cDNA traces. The shape and prominence of the trace is dependent on cell type, sublibrary size, and amount of DNA loaded into the TapeStation. Sublibraries with minor deviations can still produce high quality data.

Appendices

Appendix A: Pipetting Programs

Section 1.1. Sample Normalization

MG S1 St1 V3_5

STEPS	ACTION	DURATION
1	Initial Volumes	
2	Dilute Cells	40 min
3	"Thaw R1 Plate" message	

Section 1.2. Round 1 Plate Loading and Pooling

MG S1 St2 V3_5

STEPS	ACTION	DURATION
1	Initial Volumes	
2	Transfer Diluted Fixed Sample to Round 1 Barcoding Plate (14 μ L/well)	7 min
3	"Remove R1 plate on Deck C" message	
4	"Remove labware on Deck B" message	
5	"Move hardware on Deck B" message	
6	"Load R1 Plate on Deck B - -" message	
7	Volume Change	
8	Pool Cells into Row A (42 μ L/well)	1 min
9	Pool Cells into Row A (15 μ L/well)	1 min
10	Pool Cells into Row E (42 μ L/well)	1 min
11	Pool Cells into Row E (15 μ L/well)	1 min

Section 1.3. Round 2 Ligation Preparation

MG S1 St3 V3_5

STEPS	ACTION	DURATION
1	Initial Volumes	
2	Pool row A into 10 mL Tube with 1000 μ L tips (117 μ L/well)	4 min
3	Pool row E into 10 mL Tube with 1000 μ L tips (117 μ L/well)	4 min
4	Pool row into 10 mL Tube with 125 μ L tips (10 μ L/well)	2 min
5	Add Spin Additive	30 sec
6	"Remove 10mL Tube from Deck C" message	
7	"Thaw R2 Plate" message	
8	"Load 10mL Tube on Deck C -" message	
9-16	Remove Supernatant (3.9 mL)	2 min
17	"Checkpoint: Supernatant Removed - - " message	
18-19	Resuspend Cell Pellet with Resuspension Buffer (2 mL)	1 min
20	Add R2 Ligation Enzyme to Buffer (20 μ L)	1 min
21	Mix Ligation Mix	1 min
22	Volume Change	
23	Transfer Cells to Ligation Mix (2.3 mL)	30 sec
24	Mix Cells in Ligation Mix	30 sec
25-28	Transfer Ligation Mix to Basin (~4,2 mL)	1.5 min
29-31	Mix Sample in Basin	30 sec

Section 1.4. Round 2 Ligation

MG S1 St4 V3_5

STEPS	ACTION	DURATION
1	Initial Volumes	
2-4	Mix samples in basins	1.5 min
5-12	Load Sample into Round 2 Plate (40 μ L/well)	8 min
13	"Remove R2 Plate for incubation" message	
14	"Replace the left basin liner" message	
15	"Load R2 plate on Deck B" message	
16	"Pipette R2 Stop in Deck A" message	
17	Volume Change	
18	Add R2 Stop (10 μ L/well)	5 min
19	"Remove R2 Plate for incubation" message	
20	"Replace right basin liner" message	
21	"Load R2 Plate on Deck B" message	
22-23	Pool R2 Plate to basin (65 μ L/well)	4 min

Section 1.5. Round 3 Ligation Preparation

MG S1 St5 V3_5

STEPS	ACTION	DURATION
1	Initial Volumes	
2	"Move basin to slanted holder" message	
3	"Load cell strainer on 10 mL tube" message	
4	"Thaw R3 Plate - -" message	
5	Wash basin mix	30 sec
6	Volume change	

STEPS	ACTION	DURATION
7-11	Strain cells/nuclei (6 mL)	2 min
12	"Move Basin Holder to Deck A" message	
13	"Remove cell strainer" message	
14	Labware change	
15	Add R3 Ligation Enzyme (20 μ L)	1 min
16	Mix Ligation Enzyme with sample	1.5 min
17	Volume change	
18-22	Transfer cells/nuclei to right basin (~6.04 mL)	2 min

Section 1.6. Round 3 Ligation

MG S1 St6 V3_5

STEPS	ACTION	DURATION
1	Initial Volumes	
2-4	Mix sample in basin	1.5 min
5-12	Add sample to Round 3 Plate (50 μ L/well)	8 min
13	"Remove R3 Plate for incubation" message	
14	"Replace both basin liners" message	
15	"Reload R3 Plate on Deck B" message	
16	"Pipette R3 Stop in Deck A --" message	
17	Volume change	
18	Add R3 Stop to plate (20 μ L/well)	4.5 min
19	Pool R3 Plate (105 μ L/well)	4.5 min

Section 1.7. Pre-Lysis

MG S1 St7 V3_5

STEPS	ACTION	DURATION
1	Initial Volumes	
2	"Move Basin Holder to Deck B" message	
3	"Load cell strainer on 10 mL tube" message	
4	Wash basin	30 sec
5	Volume change	
6-12	Strain cells (~7.7 mL)	3.5 min
13	"Move Basin Holder to Deck A" message	
14	"Remove cell strainer - -" message	
15	Add Spin Additive (70 μ L)	30 sec
16	"Remove 10mL tube from Deck C" message	
17	"Load 10 mL tube on Deck C --" message	
18	Volume change	
19-23	Remove supernatant (~8 mL)	4 min
24	"Checkpoint: Supernatant Removed--" message	
25-26	Resuspend Pre-Lyse (4 mL)	2 min
27	"Remove 10mL tube from Deck C" message	
28	"Load 10 mL tube on Deck C --" message	
29	Volume change	
30-34	Remove supernatant (~4.4 mL)	2.5 min
35	"Checkpoint: Supernatant Removed - -" message	
36	"Count cells/nuclei" message	

Section 1.8. Lysis and Sublibrary Generation

MG S1 St8 V3_5

STEPS	ACTION	DURATION
1	Initial Volumes	
2-5	Aliquot 25 μ L of sample	4 min
6	Lysis Mastermix	1.5 min
7	Mix Lysis Mastermix	1 min
8	Add Lysis Mastermix to sample (30 μ L)	10 min
9	"remove PCR tubes from Deck C" message	

Section 2.1. Reagent Plating

MG S2 St1 V3_5

STEPS	ACTION	DURATION
1	Initial Volumes	
2	Dispense Streptavidin Beads (88 μ L/well)	2 min
3	Dispense SPRI Beads (160 μ L/well)	1 min
4	Dispense Binding Buffer (110 μ L/well)	2 min
5-7	Dispense Bead Wash Buffer (entire volume)	1 min
8	"Thaw Lysates" message	
9-12	Dispense Wash Buffer 1 (entire volume)	1.5 min
13-17	Dispense Wash Buffer 2 (entire volume)	1.5 min
18	"Load Wash 3-" - message	
19-22	Dispense Wash Buffer 3 (entire volume)	1.5 min
23	"Load Lysates-" message	
24	Enhancer Addition	9 min
25	"Cap and store SPRI beads at RT" message	

STEPS	ACTION	DURATION
26	"Proceed immediately to S2 St2" message	

Section 2.2. cDNA Capture

MG S2 St2 V3_5

STEPS	ACTION	DURATION
1	Initial Volumes	
2	Raise magnet	
3-4	Mix Lysates	1 min
5-7	Remove Streptavidin Bead Supernatant (entire volume)	3 min
8-15	1st Bead Wash (100 μ L/well)	4.5 min
16-23	2nd Bead Wash (100 μ L/well)	4.5 min
24-31	3rd Bead Wash (100 μ L/well)	4.5 min
32-33	Add Binding Buffer and Mix (110 μ L/well)	3 min
34-37	Add Streptavidin Beads to Sample (50 μ L/well)	1 min
38	"Vortex at 800-1k rpm for 30 mins" message	

Section 2.3. Streptavidin Beads Wash

MG S2 St3 V3_5

STEPS	ACTION	DURATION
1	Initial Volumes	
2-6	Supernatant Removal (entire volume)	3.5 min
7-15	1st Wash 1 (120 μ L/well)	8 min

STEPS	ACTION	DURATION
16-24	2nd Wash 1 (120 μ L/well)	8 min
25-32	Wash 2 (120 μ L/well)	8 min
33-34	Wash 3 (120 μ L/well)	1 min
35	"Proceed immediately to S2 St4" message	

Section 2.4. Master Mixes Preparation

MG S2 St4 V3_5

STEPS	ACTION	DURATION
1	Initial Volumes	
2-5	cDNA Amp Mix Prep: Enzyme: 1050 μ L Primer: 1050 μ L	2.5 min
6	Dispense cDNA Amp Mix to Strip Tubes (230 μ L/well)	1 min
7	"Cap and store cDNA Amp on ice—" message	
8-13	Template Switch Mix Prep: Buffer: 1710 μ L (total) Enzyme: 92.4 μ L Primer: 26.2 μ L	5 min
14	Dispense Template Switch to Strip Tubes (220 μ L/well)	1.5 min
15	"Proceed immediately to S2 St5" message	

Section 2.5. Template Switch and cDNA Amplification

MG S2 St5 V3_5

STEPS	ACTION	DURATION
1	Initial Volumes	
2-6	Remove Wash 3 Supernatant (entire volume)	4 min

STEPS	ACTION	DURATION
7-10	Adds Template Switch Mix to Samples (100 μ L/well)	4.5 min
11	"Manually Mix Samples" message	
12	"Seal and incubate at RT for 30 mins" message	
13	"Reload samples on Deck C-" message	
14-17	Mix samples	2 min
18	"Cap and run TS on thermocycler" message	
19	"Reload samples on Heatmag-" message	
20-24	Remove Template Switch Supernatant (entire volume)	3.5 min
25-27	Wash 3 (120 μ L/well)	1.5 min
28	"Load Amp Mix on Deck B-" message	
29-32	Remove Wash 3 Supernatant (entire volume)	2.5 min
33-36	Add cDNA Amp Mix to Sample (100 μ L/well)	4.5 min
37	"Manually Mix Samples" message	
38	"Run cDNA Amp on the Thermocycler" message	

Section 2.6. Post-Amplification Purification

MG S2 St6 V3_5

STEPS	ACTION	DURATION
1	Initial Volumes	
2-3	Mix Samples	1 min
4	Activate Magnet	
5-6	Mix SPRI Beads	2 min
7-9	Transfer Sample (Col 1 & 3) to Tubes (Col 5 & 7) on Heatmag (90 μ L/well)	2 min

STEPS	ACTION	DURATION
10-15	Add SPRI Beads to Samples (72 μ L/well)	9.5 min
16-22	Remove Supernatant (entire volume)	6 min
23-33	1st EtOH Wash (120 μ L/well total)	4.5 min
34-45	2nd EtOH Wash (120 μ L/well total)	6.5 min
46-57	Elution (25 μ L/well)	15 min
58	"Samples on Heatmag Column 9-11" message	

Appendix B: Troubleshooting

Error warning during the execution of a program

- In case of an error warning, abort the program. Do not press "RUN". Scroll down "Run from step". You can then continue from the error location. This allows to resume directly from the point of error.

Tip Pinching

- Tip pinching may occur when using a newly frozen PCR freezer block for a plate pooling step. Ensure that your PCR Freezer Block has been thawed at room temperature for at least 10 minutes.
- Ensure to apply sufficient pressure when placing the plate onto the frozen PCR freezer block.

Incorrect tip location inputted

- The D-ONE Pipette will check the pipette tips before the step starts. The ASSIST PLUS will display an error warning if a pipette tip is incorrectly detected. Abort and restart the program with the correct tip location input.
- The VIAFLO will check the pipette tip after the step is finished. The ASSIST PLUS will display an error warning if a pipette tip is incorrectly detected. Abort and restart the program with the correct tip location input.

Appendix C: Revision History

Version	Description	Date
1.0	Initial release	April 2024
1.1	Section 1.1: Updates Cell Number and Dilutions	May 2024
1.2	Updated configuration decks	June 2024
1.3	Updated Section 1	February 2025
1.4	Updated scripts. Added Section 2 and 3.	June 2025
1.5	Update to exclude Section 3 and related content.	July 2025
1.6	Section 2.4.7: revised Master Mix volume	November 2025

Appendix D: Acknowledgements

All graphics were created with [BioRender.com](https://www.biorender.com).



parsebiosciences.com

support@parsebiosciences.com

